

# APPENDIX A - PROCEDURE FOR DIVISION II SAILBOARDS MEASUREMENT

## PROCEDURE FOR MEASUREMENT:

The International Division II Association prescribes that compliance of Division II sailboards to their Class Measurement Rules, as set in Art 2.4, 2.5 and 3.0 must be confirmed using either a specific pentograph customized for sailboard measurement or, if not available, a method of measurement using qualified templates or gates.

Both methods of measurement are valid and are described below, as follow:

### A. THE USE OF A PENTOGAPHE FOR DIVISION II SAILBOARD MEASUREMENT.

#### A.1. Pentograph purpose and functions

- A.1.1. To measure the limit of hull thickness 220 mm
- A.1.2. To measure the limit of hull master-bau, at half height, 630 mm

The above 2 measures are performed simultaneously

- A.1.3. To measure limit of half height, 590 mm, over 1300 mm length.
- A.1.4. This pentograph works by direct measures and readings from graduated rulers or rods (similar to Gallipers or micrometers)
- A.1.5. A calibration of the pentograph is required prior to each measurement session.

#### A.2. Description of pentograph

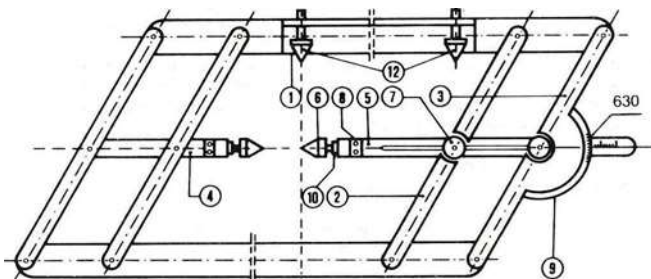

REP	NB	DESIGNATION
12	2	ATTITUDE ADJUSTMENT CYLINDER
10	1	LOCKING NUT
9	1	HEIGHT SECTOR ADJUSTMENT
8	4	SET SCREW
7	2	NUT WHEEL
6	2	ADJUSTABLE INDEX
5	1	CONTROL INDEX GUIDE
4	1	INDEX GUIDE
3	1	GRADUATED ROD
2	7	TIE ROD
1	2	SUPPORT ARM

#### A.3. Calibration of pentograph

Calibration is performed using a 630 mm long and 220 mm height template

##### A.3.1. Height of contact pins

- Will be determined at half height using a 220 mm template that is V carved in the middle
  - The N6 pin must be in contact with template into V carved
- See diagram below:

# APPENDIX A - PROCEDURE FOR DIVISION II SAILBOARDS MEASUREMENT

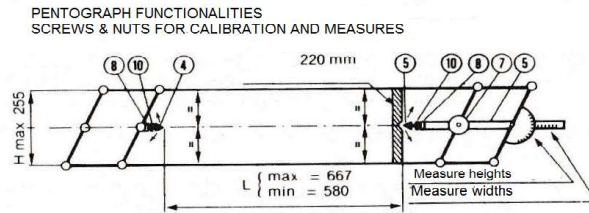

## A.3.2. Length 630 mm between contact pins

- Set graduated index at 630 mm (N5)
  - Lock nut wheel (N7)
- Insert template 630 mm between (N6 & N4) pins and make contact
  - Template must remain removable at this stage
  - Lock nut wheel N10
- See diagram below:

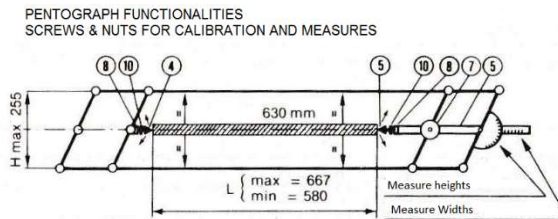

## A.4. MEASURING THE BOARD

### A.4.1. To determine the longitudinal axe

- Draw an axe in the middle of the board (use pencil)
  - See diagram below:

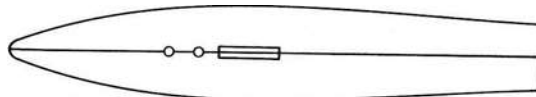

### A.4.2. To determine Maximum thickness (NMT 220 mm) and Master-bau at half height (NLT 630 mm).

Proceed as follow

- Insert pentagraph where width and thickness seem to be widest
- Use a square to ensure pentagraph is perpendicular to longitudinal axe
  - See diagram below:

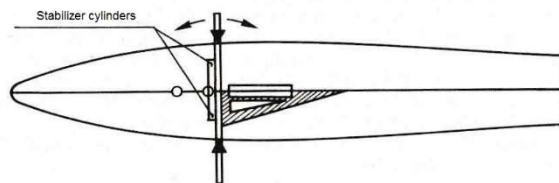

- Tighten the frame of pentagraph (top to bottom) on the deck (N12) where master-bau and thickness are estimated being the largest.
- Put pin N4 in touch with hull surface while slightly pulling the pentagraph
- Stabilize pentagraph horizontally above deck (use wedges if required)
- Tighten N6 on hull (make sure N4 & N6 reading points position are equidistant from sailboard sides – use flexible ruler if required)
  - Read on N5/N9 index
  - See diagram below:

# APPENDIX A - PROCEDURE FOR DIVISION II SAILBOARDS MEASUREMENT

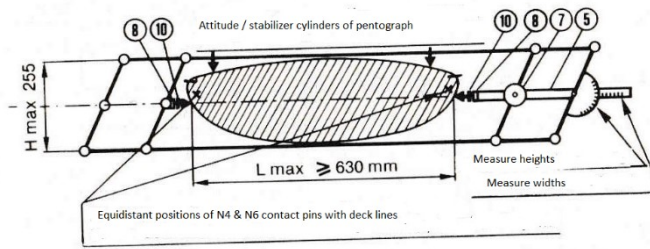

- Repeat on different points along hull surface (ensure reading points N4 & N6 remain equidistant)
  - Record each reading on N5/N9 index
  - Determine master bau position and maximum thickness at half height
    - See diagram below:

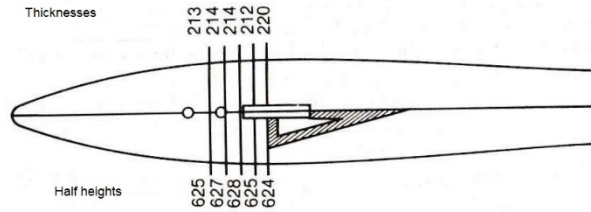

### A.4.3. To determine width at half height, at least 590 mm within 1300 mm

- Set pentagraph N4&N6 pins gap at 590 mm and lock it (N5/N9 index)
- Insert pentagraph from bow side, going backward
- Make sure pentagraph is stabilized on board deck and perpendicular to median axe (use a square if required)
- Find half height/width point 590 mm once N4&N6 pins get in contact with hull surface
- Pencil a perpendicular line to median axe to indicate pentagraph position then measure 1300 mm point going backward.
  - See diagram below:

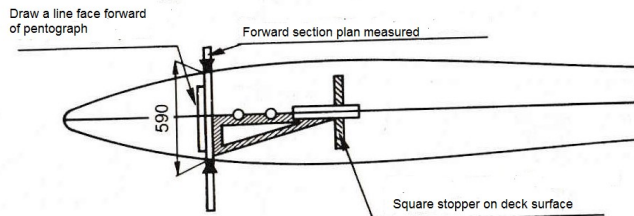

- Release pentagraph pin N6 and move backward down to 1300 mm point.
- Tighten N6 pin again against hull surface and lock it again.
  - See diagram below:

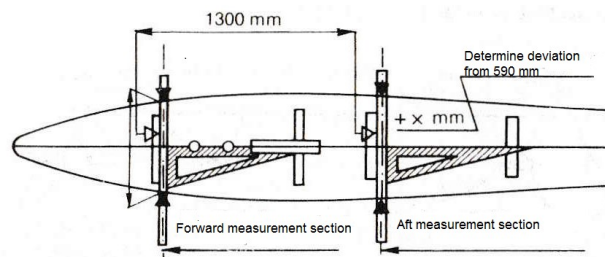

- Read and pencil value of width/gap found on index N9
- 1<sup>st</sup> Case: Value exceed 590 mm.
  - Note positive deviation on hull
- 2<sup>nd</sup> Case: Value found is less than 590 mm.

# APPENDIX A - PROCEDURE FOR DIVISION II SAILBOARDS MEASUREMENT

- Note negative deviation on hull
- Redo the above entire procedure, following same sequence (i.e. defining half height forward position 590 mm 1<sup>st</sup> then defining rear 2<sup>nd</sup>, but while moving pentograph in a different position and in such a way that half of sum of both measurements still equal 1300 mm
  - See diagram below:

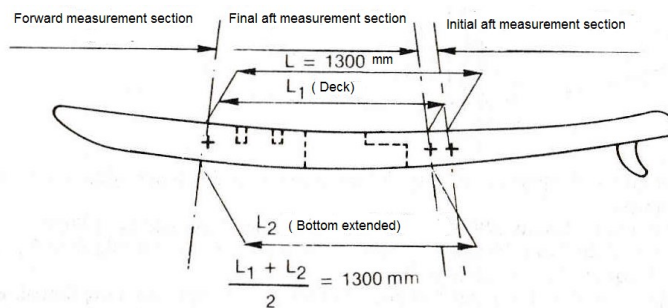

- Once locked again, read on N9 and note deviation found on hull
  - **If negative again by more than 1 mm, the board is 'Out of Specs' (OOS) therefore, not approved.**

### A.4.4. Case of local variations and irregularities on hull

- Whether they are accidental or following repairs, there should not be any variations close to or between forward and rear measurement sections susceptible to invalidate target thickness (max 220 mm), master bau (min 690 mm) and half height width (min 590 mm)

### A.4.5. To determine dagger board and fin (skeg) lengths

- Use graduated squares if required
  - See diagram below

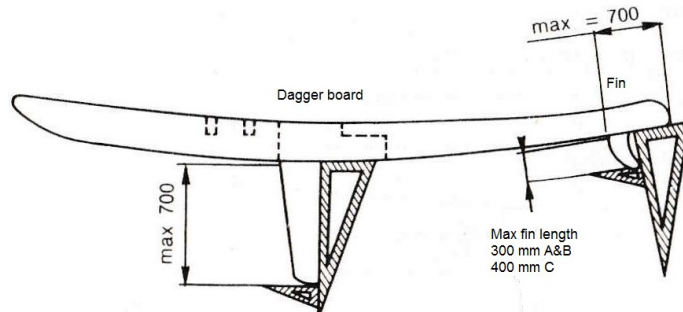

## B. SIMPLIFIED METHOD TO MEASURE DIVISION II SAILBOARDS

The "ND" simplified method is described below and requires:

- A Horizontal Gate
  - That measures maximum thickness (NMT 220 mm) of the hull and minimum width of Master-Bau (NLT 630 mm) at half height, all at once
    - See diagram below

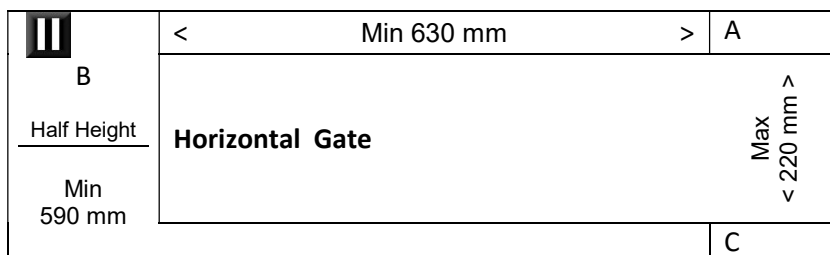

# APPENDIX A - PROCEDURE FOR DIVISION II SAILBOARDS MEASUREMENT

- Vertical Gates (2 identical gates)
  - To measure minimum width (NLT 590 mm) over 1300 mm
  - See diagram below

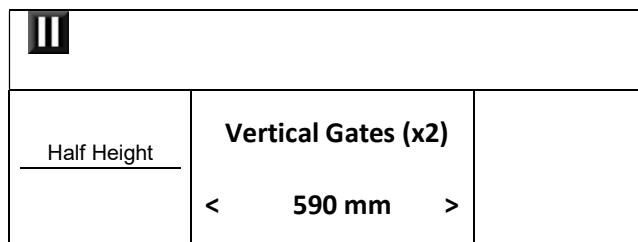

## B.1. Use of horizontal gate

B.1.1. To measure max board thickness (max 220mm)

- Insert the gate around the board and move it from the bow backward to the stern. The gate should pass along the board without difficulty
- See diagram

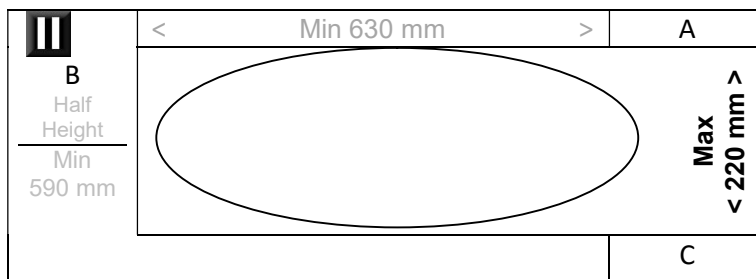

B.1.2. To measure minimum width of board at half height of Master Bau position (min 630 mm)

- Once the gate is inserted around the board, reach Master- Bau position and read value at half height against index A.
- Value should be equivalent or greater.
- See diagram

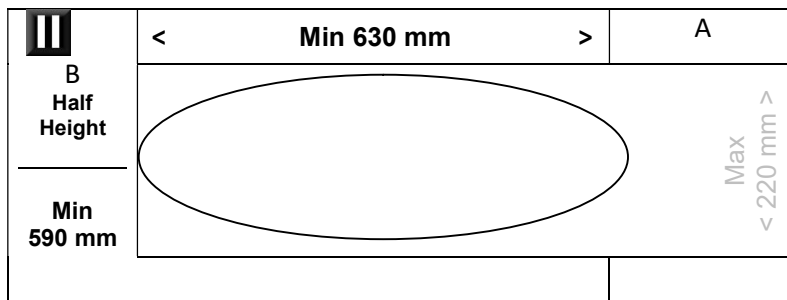

- *When there is a doubt, one needs to recalculate half height.*
  - *Max point is measured to point B and compared with the distance <top of board/top of gate>*
    - *The gap <top of gate/top of board> is measured then divided by 2*
    - *Subtract value from distance <bottom gate/point B> to determine half height.*
  - *Max width must be below that point.*

# APPENDIX A - PROCEDURE FOR DIVISION II SAILBOARDS MEASUREMENT

## B.2. The use of vertical gates

B.2.1. To measure that width of the boards, at half height, are more than 590 mm over 1300 mm length

- Gates are placed at the extremity of the board and moved toward center when they are stopped at width 590 mm.
- Distance measured between the two gates must be at least 1300 mm
  - See diagram below

