

Effective date: 2023-07(Jul)-01
Status: Approved



Class Rules

Snipe Class International Racing Association



The Snipe was designed in 1931 by William F. Crosby and was adopted as a World Sailing class in 1932. Photo taken by Matias Capizzano

sport / nature / technology



World Sailing
Class Association

Permission to use cover picture granted by SCIRA
Photo Credit to Matias Capizzano



INDEX

PART I – ADMINISTRATION

Section A – General

A.1	Language	5
A.2	Abbreviations	5
A.3	Authorities and Responsibilities ..	5
A.4	Administration of the Class	5
A.5	World Sailing Rules	5
A.6	Class Rules Variations	5
A.7	Class Rules Amendments	5
A.8	Class Rules Interpretations	5
A.9	International Class Fee.....	5
A.10	Hull Numbers	6
A.11	Hull Certificate	6
A.12	Initial Hull Certification	6
A.13	Validity of Certificate	6
A.14	Hull Re-Certification	6
A.15	Retention of Measurement Forms...	6

Section B – Boat Eligibility

B.1	Certification	7
B.2	Class association Marks	7

PART II – REQUIREMENTS AND LIMITATIONS

Section C – Conditions for Racing

C.1	General	8
C.2	Crew	8
C.3	Personal Equipment	8
C.4	Advertising	8
C.5	Portable Equipment	8
C.6	Boat	9
C.7	Hull	9
C.8	Hull Appendages.....	9
C.9	Rig	11
C.10	Sails	13

Section D– Hull

D.1	Parts	15
D.2	Hull Shell	16
D.3	Deck	17
D.4	Gunwale and sheer strakes.....	18
D.5	Bulkheads	18
D.6	Thwarts	18
D.7	Moment of Inertia	18

Section E – Hull Appendages

E.1	General	19
E.2	Daggerboard	19
E.3	Rudder Blade, Tiller and Extension	20

Section F – Rig

F.1	Rules	20
F.2	Manufacturers	20
F.3	Mast	20
F.4	Boom	21
F.5	Whiskerpole	22
F.6	Standing Rigging	22
F.7	Running Rigging	22

Section G – Sails

G.1	Parts	23
G.2	General	23
G.3	Mainsail.....	23
G.4	Jib	24

PART III – APPENDIX

H	Figures.....	25
---	--------------	----

INTRODUCTION

This introduction only provides an informal background and the international Snipe Class Rules proper begin on the next page.

Snipe hulls, hull appendages, rigs and sails are measurement controlled. Equipment is required to comply with the International Snipe Building Specification.

Measurement procedures and tools are explained in the Measurers' Handbook furnished by SCIRA

Snipe hulls, hull appendages, rigs and sails may, after having left the manufacturer, only be altered to the extent permitted in Section C of the class rules.

Rules regulating the use of equipment during a race are contained in Section C of these class rules, in Equipment Rules of Sailing (ERS) Part I and in the Racing Rules of Sailing.

Owners and crews should be aware that compliance with rules in Section C is not checked as part of the certification process.

PLEASE REMEMBER:

THESE RULES ARE **CLOSED CLASS RULES** WHERE IF IT DOES NOT SPECIFICALLY SAY THAT YOU MAY – THEN YOU SHALL NOT.

PART I – ADMINISTRATION

Section A – General

A.1 LANGUAGE

- A.1.1 The official language of the class is English and in case of dispute over translation the English text shall prevail.
- A.1.2 The word “shall” is mandatory and the word “may” is permissive.

A.2 ABBREVIATIONS

- A.2.1 WS World Sailing
- MNA WS Member National Authority
- SCIRA Snipe Class Int. Racing Association
- NCA National Snipe Class Association
- ERS Equipment Rules of Sailing
- RRS Racing Rules of Sailing

A.3 AUTHORITIES AND RESPONSIBILITIES

- A.3.1 The International Authority of the class is SCIRA, which shall co-operate with World Sailing in all matters concerning these **class rules**.
- A.3.2 Notwithstanding anything contained herein, SCIRA has the authority to withdraw a **certificate** and shall do so on the request of World Sailing.
- A.3.3 Neither World Sailing, an MNA, SCIRA, an NCA, or an **official measurer** are under any legal responsibility in respect of these **class rules** and the accuracy of measurement, nor can any claims arising from these be entertained.

A.4 ADMINISTRATION OF THE CLASS

- A.4.1 World Sailing has delegated the administrative functions of the class to SCIRA. SCIRA may delegate part of its functions, as stated in these **class rules**, to an NCA
- A.4.2 An NCA is the **Certification Authority** appointed by the SCIRA.

A.5 WORLD SAILING RULES

- A.5.1 These **class rules** shall be read in conjunction with the current version of the ERS.
- A.5.2 Except where used in headings, when a term is printed in “**bold**” the definition in the ERS applies and when a term is printed in “*italics*” the definition in the RRS applies.
- A.5.3 These rules are complementary to the Building Specification Plan and Measurement Data Sheet (MDS).

A.6 CLASS RULES VARIATIONS

- A.6.1 At Class events – see RRS 89.1.d) – WS Regulation 10.5(f) applies. At all other events RRS 87 applies.

A.7 CLASS RULES AMENDMENTS

- A.7.1 Amendments to these **class rules** are subject to the approval of the WS in accordance with the WS Regulations.

A.8 CLASS RULES INTERPRETATIONS

- A.8.1 Interpretations of these **class rules** shall be made in accordance with the WS Regulations.

A.9 INTERNATIONAL CLASS FEE

- A.9.1 The licensed hull builder shall pay the International Class Fee to SCIRA.

A.10 HULL NUMBERS

A.10.1 Hull numbers shall be issued by SCIRA.

A.10.2 Hull numbers shall be issued in consecutive order starting at "1".

A.11 HULL CERTIFICATE

A.11.1 No **boat** shall take part in a race unless it has a valid measurement **certificate** and Measurement Data Sheet (MDS).

A.11.2 A **certificate** shall record at least the following information:

- (a) Class.
- (b) Number of Measurement Certificate (Optional).
- (c) Hull number issued by SCIRA.
- (d) Builder/Manufacturers details.
- (e) Owner's name and address.
- (f) Country of registration.
- (g) Total weight of the boat.
- (h) Location and amount of the corrector weights (hull and mast).
- (i) Moment of Inertia.
- (j) Measurer's name and stamp.
- (k) Date of issue of the initial certificate.
- (l) National Secretary name & stamp.
- (m) Owner's signature

A.12 INITIAL HULL CERTIFICATION

A.12.1 For a **certificate** to be issued to a **hull** not previously certified:

- (a) Equipment certification measurement shall be carried out by an **official measurer** who shall complete the Measurement Data Sheet (MDS) provided by SCIRA.
- (b) The MDS and certification fee, if required, shall be paid to the Measurer.
- (c) Upon receipt of a satisfactorily completed MDS, the **Certification Authority** may issue a **certificate**.

A.13 VALIDITY OF CERTIFICATE

A.13.1 A hull **certificate** becomes invalid upon:

- (a) The change to any items recorded on the **hull certificate** as required under A.11 or the MDS.
- (b) Withdrawal by SCIRA or NCA,
- (c) The issue of a new **certificate**.

A.13.2 **Hulls** built before January 1st 1976 that have not been modified in their shape or materials need not be recertified.

A.14 HULL RE-CERTIFICATION

A.14.1 The **Certification Authority** may issue a new **certificate** to a previously certified **hull**:

- (a) When the **certificate** becomes invalid under A.13.1(a) after receipt of the old **certificate** and **certification** fee, if required,
- (b) When it is invalidated under A.13.1 (b), at its discretion.
- (c) In other cases, by application of the procedure in A.12.

A.14.2 If a **certificate** is lost, a replacement may be issued by the **Certification Authority**.

A.15 RETENTION OF MEASUREMENT FORMS

A.15.1 The **Certification Authority** shall:

- (a) Retain the original MDS upon which the current **certificate** is based with a copy to the SCIRA International office.

- (b) Upon request, transfer the **certificate** to the new **Certification Authority** if the **hull** is sold to a different Country.

Section B – Boat Eligibility

For a **boat** to be eligible for *racing*, it shall comply with the **Class Rules** in this section.

B.1 CERTIFICATION

B.1.1 The **boat** shall:

- (a) Have a valid measurement **certificate**.
- (b) Have valid **certification marks** as required.

B.2 CLASS ASSOCIATION MARKINGS

B.2.1 A valid Class Association Sticker of the year of the competition shall be affixed to the **hull** in the aft part of starboard side.

B.2.2 **Sails** shall carry the Class Association Sail Label.

B.2.3 **Hulls** shall display the measurement label approved by the class indicating the hull number, the date of measurement, the amount and position of all the **corrector weights**.

PART II – REQUIREMENTS AND LIMITATIONS

The **crew** and the **boat** shall comply with the rules in Part II when *racing*. In case of conflict Section C shall prevail.

The rules in Part II are **closed class rules**. Certification control and **equipment inspection** shall be carried out in accordance with the ERS except where varied in this Part.

Section C - Conditions for racing

C.1 GENERAL

C.1.1 RULES

- (a) The **hull** shall comply with the **class rules** in force at the time of initial **certification** except when differently specified in these **class rules**.

C.2 CREW

C.2.1 LIMITATIONS

- (a) The **crew** shall consist of 2 persons.
- (b) No **crew** shall be substituted during an event unless authorised by the Race Committee.

C.3 PERSONAL EQUIPMENT

C.3.1 PERSONAL FLOATATION DEVICE

- (a) The boat shall be equipped with a personal flotation device for each crew member to the minimum standard ISO 12402-5, or USCG Type III, or AS 4758 Level 50 or equivalent. Inflatable buoyancy vests are not permitted.

C.4 ADVERTISING

Advertising is permitted only in accordance with World Sailing Regulation 20 Advertising Code.

C.5 PORTABLE EQUIPMENT

C.5.1 FOR USE

(a) OPTIONAL

- 1) Any electronic or mechanical timing devices.
- 2) Any magnetic compass.
- 3) Any multi function electronic compass with steering and time functions only.
- 4) Spare parts such as blocks, shackles, ropes, lines, tools such as knife, screwdriver, whistle.
- 5) Any compass bracket.

C.5.2 NOT FOR USE

(a) MANDATORY

- 1) Any floating single towing line of minimum 15m long and not less than 8mm in diameter. It shall not be stored inside watertight tanks.
- 2) Any paddle.

C.6 BOAT

C.6.1 WEIGHT

	minimum	maximum
The boat weight in dry conditions including compass and shall be:	172.8 kg	
The total weight of corrector weights shall be		15 kg

C.6.2 CORRECTOR WEIGHTS

- (a) **Corrector weights** shall be permanently fastened in a visible position. If located inside the tight compartment they must be visible through the inspection ports.

C.6.3 FLOTATION

- (a) All **boats** shall comply the following flotation requirements: when the **boat** has been capsized and has remained in any position long enough to take in as much water as possible in high wave conditions, it shall, upon being righted, float so that the lowest point around the cockpit edge where water might enter the boat is at least 152 mm above the water when the **boat** is supporting 136kg. This may be accomplished by means of tank, flotation bags, self bailing cockpits, increased low density flotation material, or other suitable means. Holes with maximum 645 sq. cm. may be made in the transom to facilitate drainage. Where transom drains are used to comply with this rule they should have a minimum of 290 sq. cm. total.

For **boats** built before Jan. 1, 2001 meeting the requirement of this rule, the daggerboard case shall have a minimum height of 229 mm above the outside of the **keel** if the **boat**, after capsizing and being righted, floats high enough so that water will flow out of the trunk; otherwise, the trunk shall be 51 mm above the water level in the boat after capsizing and being righted.

C.7 HULL

C.7.1 MODIFICATIONS MAINTENANCE AND REPAIR

- (a) The hull shell, deck, bulkheads and cockpit floor as supplied by the manufacturer shall not be altered in any way except as permitted by these **class rules**.
- (b) Routine maintenance such as small repairs, painting, sanding and polishing is permitted without re-measurement and re-certification.
- (c) If the **hull** is repaired in any other way than described in C.7.1 (b) an **official measurer** shall verify that part to comply with these **class rules** and that no substantial advantage has been gained as a result of the repair. The **official measurer** shall describe the details of the repair on the **certificate**.

C.7.2 LIMITATIONS

- (a) Only one **hull** shall be used during an event, except when lost or damaged beyond repair. A replacement shall only be made with the approval of the Race Committee.
- (b) Inspection hatch covers and drainage plugs shall be kept in place at all times.

C.8 HULL APPENDAGES

C.8.1 GENERAL

- (a) **Hull appendages** shall comply with the **class rules** in force at the time of initial **certification** unless otherwise prescribed in these **class rules**.

C.8.2 MODIFICATIONS MAINTENANCE AND REPAIR

- (a) **Hull appendages** shall not be altered in any way except as permitted by these **class rules**.
- (b) Routine maintenance such as small repairs, painting, sanding and polishing is permitted without re-measurement and re-certification.

C.8.3 LIMITATIONS

- (a) Only one **daggerboard** and one **rudder** blade shall be used during an event, except when an item has been lost or damaged beyond repair. A replacement shall only be made with the approval of the Race Committee.

C.8.4 DAGGERBOARD

(a) LIMITATIONS

- 1) The **daggerboard** shall be installed in such a manner that the trailing edge of the **daggerboard** is approximately perpendicular to the base line when the **daggerboard** is completely lowered.
- 2) There shall be a permanent stopper positioned so that the lowest point of the **daggerboard** to its closest point on the **hull** shall be maximum 851mm.
- 3) The **daggerboard** retracted position limit mark shall be:
 - When positioned with the top of the mark even with the top surface of the deck at the centreline of the **boat** the lowest point of the **daggerboard** to its closest point on the **hull** shall be minimum 305mm.
 - Minimum 25 mm high.
 - Minimum 350 mm long extending from the front of the **daggerboard**
 - Painted using varnish or permanent marker in a contrasting colour and on port and starboard sides.
- 4) The top of the **daggerboard** retracted position limit mark shall not be above the top surface of the deck at the centreline of the **boat**.
- 5) The **daggerboard** shall be attached to the hull with a single safety line at all times while sailing (unless for a short period for cleaning garbage or seaweed). The safety line shall be of size no smaller than 4mm in diameter and shall not be adjustable. Non-stretching lines are recommended. Any knot or locking splice in the line must not be adjustable. If a knot is used, it must be sewn in such a way that it cannot be adjusted and the line will be cut to eliminate excesses, and shall be fixed to any part of the **daggerboard** case and directly fastened to the **daggerboard** with a metal shackle or carabiner above the line connecting the lower part of the stoppers and the **daggerboard**. No middle knots in the line are allowed. The use of a steel wire is also permitted with minimum diameter of 1mm.
- 6) The maximum length of this safety line from the top of the **daggerboard** case to the inner part of the shackle pin shall be 610mm.
- 7) The retaining system shall either consist of a flipping tablet or/and a hook and cutouts on the **daggerboard** and shall permit the crew to extend the board completely when the boat is capsized without swimming under the boat.
- 8) **Boats** built before 1976 may use **daggerboards** with thickness between 7.5mm and 8mm
- 9) Any seals on the **daggerboard** case may be used only at the top of the daggerboard case.
- 10) Strips of any material except carbon or exotic materials may be added on the **daggerboard** blade or inside the **daggerboard** case to limit the side movement of the **daggerboard**. Stripes shall not be used as retaining system.

C.8.5 RUDDER

(a) LIMITATIONS

- 1) The **rudder** shall be fitted to the transom in such a manner that it will not detach from the **hull** if the **boat** capsizes.

- 2) Hulls measured before February 26, 2018 may use any allowed rudder specified in E.3.4.a).
- 3) For **hulls** built before 1st January 2013 **corrector weights** of maximum 450 grams are permitted in the **rudder**. For **hulls** built from 1st January 2013 **corrector weights** of maximum 250 grams are permitted in the **rudder**.
- 4) For **hulls** built from 1st January 2001 the diameter of the pintles shall be between 7.5mm and 8mm. For **hulls** built before 1st January 2001 there is no limitations in the diameter of the pintles.
- 5) The tiller shall be attached directly to the **rudder** head above the deck and shall not slide fore and aft more than 2mm in any direction. It shall not extend the outermost part of the rudder head more than 2mm.
- 6) Any tiller extension may be used.
- 7) The leading edge of the **rudder** shall be parallel to the transom from the **rudder** datum point to the sheer with a max tolerance of 2mm and shall have 38mm of maximum clearance from the transom.
- 8) The projection of the centreline of the keel line extended as necessary shall cross the vertical projection of the **rudder** in a point maximum 6 mm above or below the **rudder datum point**.
- 9) Pivoting **rudders** may be used only in regattas limited by local conditions. SCIRA shall authorise their use in the NoR or SI. Pivoting **rudders** shall not be allowed in any regatta using the SCIRA Rules of Conducting National and International Championship Regattas.

C.9 RIG

C.9.1 MODIFICATIONS, MAINTENANCE AND REPAIR

- (a) **Rigs** shall not be altered in any way except as permitted by these **class rules**.
- (b) Routine **maintenance** such as small **repairs**, painting, **sanding** and polishing is permitted without re-measurement.

C.9.2 LIMITATIONS

- (a) Only one **mast**, one **boom** and one **whisker pole** shall be used during an event except when an item has been lost or damaged beyond repair. A replacement shall only be made with the approval of the Race Committee.
- (b) **Limit marks** shall be taped or painted of contrasting colour with the spars with a minimum width of 25 mm.
- (c) The distance from the **upper point** to the **lower point** in the **mast** spar shall be a maximum of 5112mm
- (d) For **masts** to be rigged on **boats** built before January 1st 2001 the following limitations shall apply:

	minimum	maximum
Distance from the mast datum point to the upper point		6109mm

- (e) For **masts** to be rigged on **boats** built between January 1st 1992 to Dec 31st 2000 the following limitations apply:

	minimum	maximum
The distance between the forestay , shrouds and jib halyard's rigging point above the mast datum point shall be	4470mm	4572mm

- (f) For **masts** to be rigged on **boats** built from January 1st 2010 the following limitations shall apply:

	minimum	maximum

The gooseneck length, measured from the aft edge of the mast to the connection of the boom shall be		42mm
Gooseneck diameter (if round) Gooseneck size (if squar)		13mm 13x13mm

- (g) For **booms** to be rigged on **boats** built from January 1st 2010 the following limitations shall apply:

Boom hole size to connect gooseneck	minimum	maximum
If round	13mm	14mm
If squared		14x14mm

C.9.3 CONDITIONS FOR USE, MAST

- (a) Halyards shall be set inside or outside the **mast**.
- (b) **Masts** shall only have attached one **forestay** and two side **shrouds**.
- (c) The **mast spar** shall not be adjusted at the **mast** step while racing. The butt of the **mast** shall be limited at the **mast** step by one transverse pin. Any **mast** step with a sliding adjustment system is allowed, providing that the position of the slider is fixed by a bolt and nut or a screw.
- (d) The butt of the **mast** spar shall be attached to the mast step with a safety latch or any alternative fitting. Tight rig is considered equivalent.
- (e) The **mast spar** shall be stepped in the **mast** step in such a way that the **heel point** shall not move more than 2mm in any direction.
- (f) For boats built before January 1st 2001 only, the **mast** shall be stepped on keel or on the flotation tank with a max tolerance of 51mm
- (g) Movements of the **mast** shall be restrained by fore and/or aft guys or mechanical restraint **connected** to the **mast** below the **lower point**, or blocks at deck level.
- (h) Any stopper shall be placed 5mm above at the **upper point** to prevent the **mainsail** to be hoisted above the **upper limit mark**. **Mast spars** with **halyard** locks at **mast** head shall not be required to have the stopper.
- (i) Rigging links and rigging screws shall not be adjusted while *racing*.
- (j) Spreaders shall not be adjusted while racing.
- (k) The **mast** fitting block from which a retractable **whisker pole** is launched shall not project further than the forward edge of the **mast**.

C.9.4 CONDITION FOR USE, BOOM

- (a) The intersection of the aft edge of the **mast spar** and the top edge of the **boom spar**, each extended as necessary, shall not be below the mast **lower point** when the **boom spar** is at 90° to the **mast spar**.
- (b) Any stopper shall be positioned on the **boom** to prevent the **clew point** stretching beyond the **outer point**.
- (c) Maximum **boom spar** curvature is 10mm

C.9.5 CONDITIONS FOR USE, WHISKERPOLE

- (a) The **whisker pole** shall not extend ahead of the bow or abaft the end of the **boom** when not in use.
- (b) The use of blocks and shock cord for the **whisker pole** launcher and retractor system is permitted.

C.9.6 CONDITIONS FOR USE, STANDING RIGGING

- (a) The length of the **shrouds** and the **forestay** shall not be adjusted while racing.
- (b) The length of the **forestay** shall prevent the **mast** to touch the aft side of the hole in the deck when the pusher-puller is disconnected.
- (c) The use of shock cord while racing to remove slack of **forestay** and between the **shrouds** and the **mast** is permitted.

C.9.7 CONDITIONS FOR USE, RUNNING RIGGING

- (a) The jib shall be sheeted inside or outside the **shrouds**.
- (b) The **mainsail sheet** shall be led by any bridles and may be adjusted while racing.
- (c) The **mainsail outhaul** may be adjusted while racing.
- (d) The cunningham controls may be adjusted while racing.

C.10 SAILS

C.10.1 GENERAL

- (a) **Sails** manufactured before 1st January 2000 shall comply with the rules in force at the time of manufacturing.
- (b) **Sails** manufactured from 1st January 2000 shall comply with these **class rules**.

C.10.2 MODIFICATIONS MAINTENANCE AND REPAIR

- (a) **Sails** shall not be altered in any way except as permitted by these **class rules**.
- (b) Routine **maintenance** such as sewing, mending and patching is permitted without re-measurement.

C.10.3 LIMITATIONS

- (a) No more than 2 **mainsails** and 2 **jibs** shall be used during an event except when a **sail** has been lost or damaged beyond repair. A replacement shall only be made with the approval of the Race Committee.
- (b) **Crews** may use the sail number of any **hull** which dues for the current year have been paid. If the sail number is different from the hull number, the **crew** shall submit a request to the Race Committee. If a **crew** owns more than one **boat** he/she may use the sail number of any of his/her boats. In case of any duplicate, the Race Committee will authorize the change at its discretion.
- (c) For **mainsail** built before Jan, 1st 2000 the maximum dimension across the **sail** from the mid point of the **luff** to the mid point of the **leech** shall be 1791mm. Determine the mid point of the **luff** by folding the **sail** until the centre of the grommet in the **head** coincides with the centre of the grommet at the **tack**. Determine the mid point of the **leech** using the **head** grommet and the grommet at the **clew**. The measurements are from the inside of the boltrope to the **leech** and shall be checked with only enough tension to remove wrinkles.
- (d) Jibs with the minimum cloth weight of 160 gr/sqm shall be used in national championships, in all international regattas with a Deed of Gift published in the Snipe Rulebook and in major Regional Championships such as Pan American Games and South American Games.

C.10.4 IDENTIFICATION

- (a) The national letters and sail numbers shall be located on the **mainsail** and shall comply with the RRS Appendix G except where otherwise prescribed in these **class rules**.
- (b) Characters on **mainsails** shall be placed as follow, from the top: class insignia, national letters, sail numbers.
- (c) The class insignia shall be located immediately above the top **batten** and shall be the reproduction of the official insignia, which shall be obtained from the Executive Director.
- (d) Insignia denoting honour awards shall consist of a chevron as shown below, which may be used in six colours as designated. No **sail** shall display more than one chevron, and it shall correspond to the highest Championship won. Honours won and displayed on sails are

awarded on a permanent basis, to the skipper and not to the boat. Honour award chevron shall be displayed immediately below the top **batten**.

- (e) The insignia and chevron shall be centred between **leech** and **luff**.

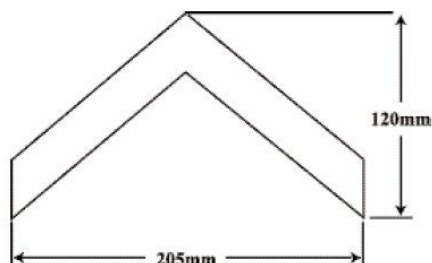

Gold	World Champion
Silver	European or Western Hemisphere and Orient Champion
Red	National Champion
Blue	Junior National Champion
Green	Winner of an Invitational or District Regatta in which boats from five or more fleets have participated
Black	Fleet Champion

C.10.5 CONDITIONS FOR USE, MAINSAIL

- (a) The **mainsail** shall be hoisted and lowered on a **halyard**. The arrangement shall permit hoisting and lowering of the sail while afloat. The **halyard** may be adjusted while racing.

Mainsail shall be set as defined in ERS B.1 The **luff** and **foot** bolt ropes shall be in the **spar** grooves or tracks at all times.

C.10.6 CONDITIONS FOR USE, JIB

- (a) The jib shall be hoisted and lowered on a **halyard**, which shall be connected to the luff wire or line by any system. The **halyard** may be adjusted while racing.
- (b) The jib shall have a wire or a fibre line (excluding PBO and carbon) fastened inside the **luff** while racing.
- (c) The jib luff wire or line shall be attached to the deck and it shall not be adjusted while racing.
- (d) Jibs shall be capable of being attached to the **forestay** fitting without disconnecting the **forestay**.
- (e) The use of **jib hanks** is optional. If used, there shall be minimum 5 and maximum 10 **hanks**. If sleeves are used a maximum of 254 mm of the **forestay** shall be covered.

Section D – Hull

D.1 PARTS

- (a) Mandatory
 - (1) **Hull** shell
 - (2) Deck
 - (3) Daggerboard case
- (b) Optional
 - (1) Bulkheads
 - (2) Thwarts
 - (3) Gunwale Sheer Strakes
 - (4) Floorboards or self-bailing cockpit
 - (5) Bailers

D.1.1 MODIFICATIONS, MAINTENANCE AND REPAIR

The **hull** shall not be altered in any way except as permitted by these **class rules**.

D.1.2 DEFINITIONS

(a) **Hull datum point**

The **hull datum point** (point 0) shall be a point on the **boat** obtained with the intersection between the bow line and the deck plane.

(b) Bare Hull

Assembled **hull** with the following fittings: jib **forestay** attachment, **shroud** attachment, **mast** step, gudgeons, bailers.

D.1.3 IDENTIFICATION

- (a) The **hull** number shall be permanent and indelibly marked in a visible and non-removable part of the **daggerboard** case or cockpit floor with numbers in figures of a minimum height of 13 mm.

D.1.4 MANUFACTURERS

- (a) Glass Reinforced Plastic (GRP) **hulls** shall be built by a builder licensed by SCIRA.
- (b) All moulds and method of construction of GRP **hulls** shall be approved by SCIRA.
- (c) Wooden or plywood **hulls** can be built by anyone. No licence is required.

D.1.5 MATERIALS

- (a) The **hull** and any part moulded with the **hull** shall be built from a combination of one or more of the following materials: wood, GRP with woven roving or mat, with either polyester or epoxy resins. Glass content shall be at least 30% by weight. The following exceptions are permitted:
 - 1) Local reinforcement of GRP , wood, plywood or metal as backing for fittings may be added.
 - 2) Carbon or aramid fibres may be used only in the splash board if it is not moulded with the **boat**.
 - 3) The **deck** may be made out of plywood

D.1.6 WEIGHT

	minimum	maximum
The bare hull weight excluding correctors weights shall be	125,2 kg	

D.2 HULL SHELL

D.2.1 FITTINGS

The following fittings shall be fitted

- (a) Any lower gudgeon.
- (b) Any upper gudgeon.
- (c) Any **mast** step.

D.2.2 DIMENSIONS AND DEFINITIONS

See Part III.H1

(a) The baseline shall be on the centre plane of the hull at the following vertical distances:

162 mm at Station 1

114 mm at Station 5

(b) The Stations shall be taken as vertical, transverse planes at the following positions on the baseline:

Station 1: at 788 mm from hull datum point

Station 2: at 1575 mm from hull datum point

Station 3: at 2362 mm from hull datum point

Station 4: at 3149 mm from hull datum point

Station 5: at 3936 mm from hull datum point

Station 6: at 4711-4737 mm from hull datum point

(c) The keel line shall be taken as the intersection line from transom to stem of the hull shell and the hull centre plane.

(d) The chine line shall be the intersection between the topside and the bottom planes.

(e) The segments of any transverse section of the bottom and side panels from Station 1 to 6 including the transom shall be straight with a maximum tolerance of 1%.

D.2.3 DIMENSIONS

	minimum	maximum
Chine radius		
At Station 1		19 mm
At Station 2 from there aft		3 mm
Length of daggerboard case slot		546 mm
Width of daggerboard case slot		
If made out of fiberglass		13 mm
If made out of wood or plywood		14 mm
Daggerboard case height at aft side	310 mm	313 mm
Top of daggerboard case parallel to base line. Tolerance		2 mm
Aft edge of slot perpendicular to base line. Tolerance at top		2 mm
Forward edge perpendicular to base line. Tolerance at top		6 mm
Vertical distance perpendicular to the sheer from bottom of mast step to mast datum point	390 mm	400 mm
Gudgeons internal diameter	8.0 mm	8.5 mm
Distance from upper side of upper gudgeon to centre plane of keel	407 mm	413 mm
Distance from upper side of lower gudgeon to centre plane of keel	152 mm	158 mm

D.2.4 HULL SHELL THICKNESS

Material allowed	minimum	maximum
Wood		
density > 512 kg per cu meter	13 mm	
density ≤ 512 kg per cu meter	19 mm	
Plywood shall have density > 5,65 kg per cubic meter	10 mm	
Plywood and GRP	10 mm Plus unlimited GRP	

The thickness of the **hull** shell shall be uniform except where reinforced locally such as at **keel**, chine, stem, **mast** step and where the **standing rigging** anchorages and **rudder** gudgeons are attached. Increased thickness due to incorporation of flotation materials in either the side or bottom of the **hull** shall be accepted.

D.2.5 CONSTRUCTION OF BOATS MADE OUT OF GRP

- The floorboards may be bonded directly to the bottom of the **boat**, omitting support. A floor structure made out of GRP and foam may be used.
- In self bailing cockpits there are no restrictions on method of construction.
- A minimum of 0,184 cubic metres of Styrofoam, Urethane foam, balsa wood or foam enclosed in resin pre-impregnated fibreglass having a maximum density of 110kg per cubic metres shall be built anywhere into the **hull**.

D.2.6 CONSTRUCTION OF BOATS MADE OUT OF PLYWOOD

- If less than 10 mm is used throughout the **hull** construction, any material as per D.1.5 may be used as cover.
- 0,085 cubic meter of foam shall be installed anywhere into the **hull**.

D.3 DECK

D.3.1 FITTINGS

- The following fittings shall be fitted in accordance with the measurement diagram:
 - The **forestay** fitting shall be positioned with the fore hole between 279 and 330mm aft **hull datum point**, measured parallel to the base line and no more than 45mm above the sheer line. Max diameter of fore hole 6mm. The fitting shall be capable to be connected to the currently approved moment of inertia spring attachment.
 - Shroud** anchorages may be above or under deck. Plates or through the deck fairleads shall be positioned between 1778 and 1981mm aft the **hull datum point** and no more than 102mm inside the **sheer line**.

D.3.2 DIMENSIONS

	minimum	maximum
Foredeck aft of hull datum point	1842 mm	
Afterdeck length	457 mm	
Deck height from sheer		127 mm
Splash board height from the deck	51 mm	
Splash board length with minimum height each side, including curvature at deck level	610 mm	
Mast spar hole at deck from hull datum point	1494 mm	1748 mm
Longitudinal dimension of mast spar hole at deck		254 mm
Width of mast spar hole at deck		76 mm

Width of the cockpit Decks including side flotation tanks and/or cockpit floors shall be checked at the intersection of the deck with a plane 51 mm below the sheer. Corners may be square or round to any desired radius		1016 mm
--	--	---------

D.3.3 MATERIALS

- (a) Decks made entirely out of fiberglass may use any allowed sandwich construction.
- (b) Total Deck Thickness:

Material	minimum
Plywood	6mm
Fiberglass	1.5mm
Fiberglass sandwich	1.5mm

D.4 GUNWALE AND SHEER STRAKES

D.4.1 MATERIALS

- (a) Only a combination of one or more of the following materials are permitted: wood and/or GRP with woven roving or mat, and with either polyester or epoxy resins. Glass content shall be at least 30% by weight.

D.4.2 DIMENSIONS

- (a) The sheer strakes shall be maximum 32 mm measured horizontally from the sheer line.
- (b) The gunwale maximum radius shall be 12 mm.

D.5 BULKHEADS

D.5.1 MATERIALS

- (a) Shall be made out of wood, plywood or GRP.

D.5.2 CONSTRUCTION

- (a) Shall comply with the Snipe building plans available from the SCIRA office.

D.6 THWARTS

D.6.1 MATERIALS

- (a) Shall be made of wood, plywood or GRP.

D.6.2 CONSTRUCTION

- (a) Shall comply with the Snipe building plans available from the SCIRA office.

D.7 MOMENT OF INERTIA

Hulls with any optional and mandatory equipment and including hiking straps, any controls, mainsheet and compass if fixed on the hull, but excluding the jib sheet, shall be subject to the moment of inertia test (see Part III.H3). All hiking straps, sheets and control lines shall be in dry condition; the mainsheet shall be deployed as close as possible to the CG on the cockpit floor. The moment of inertia of the **hull** is calculated from the following formula:

$$I = \frac{CD^2T^2}{4\pi^2}$$

Where: I = Moment of Inertia

C = Spring constant, kg/sec².
 D = Distance to axis, m.
 T = Time of one complete oscillation, seconds
 $\pi = 3.1416$

For our purpose, D = 2.6233 m.

The spring constant will be furnished with springs from SCIRA.

The maximum weight of the attachment shall be 350gr excluding the springs only; if desired, **corrector weights** shall be added to the aftermost part of the attachment to reach the maximum weight.

We can now simplify the formula to:

$$I = \frac{(2.6233\text{m})^2 CT^2}{4 \times 3.1416^2} = (0.1743\text{m}^2)CT^2$$

- (a) The minimum moment of inertia of the **hull** as determined from above formula shall be: 271 Kg*m²
- (b) If the **hull** moment of inertia does not meet the minimum, weight shall be moved to or added to the ends to bring it up to the minimum.

Section E – Hull appendages

E.1 GENERAL

E.1.1 RULES

- (a) **Hull appendages** shall comply with these **class rules**.

E.1.2 MODIFICATIONS, MAINTENANCE AND REPAIR

- (a) **Hull appendages** shall not be altered in any way except as permitted by these **class rules**.

E.1.3 MANUFACTURERS

- (a) The manufacturer is optional.

E.2 DAGGERBOARD

E.2.1 MATERIALS

- (a) For the construction of the **daggerboard** only aluminium alloy with minimum mechanical characteristics of 6061T6 is permitted. The **daggerboard** may be anodized or painted.

E.2.2 DIMENSIONS

See also Part III.H.4 for the shape and the cut out for lightness.

	minimum	maximum
Thickness	9.5 mm	10.5 mm
Tapering permitted from the edges		25 mm
Radius of bottom corners:		13 mm

E.2.3 LIMITATIONS

- (a) The thickness of the **daggerboard** shall be uniform. Changes in the weight distribution are allowed according to Part III.H.4

E.3 RUDDER BLADE, TILLER AND EXTENSION

E.3.1 DEFINITIONS

- (a) The **rudder datum point** is the intersection between the leading edge of the **rudder** blade and the front edge of the **rudder** above the water line.

E.3.2 MATERIALS

- (a) The **rudder** blade shall be built from a combination of one or more of the following materials: Wood and/or GRP, or GRP and foam.
- (b) The tiller shall be built from a combination of one or more of the following materials: Wood, Aluminium alloy, GRP.

E.3.3 WEIGHT

	minimum	maximum
Weight of the rudder blade including fittings and corrector weights	2720 g	
Rudder corrector weights :		250 g

E.3.4 DIMENSIONS

See Part III.H.5

	minimum	maximum
Thickness (except the tiller connection area where there is no limitation of the thickness)	19 mm	38 mm

- (a) The cross section width shall be a minimum of 140mm measured at 90 degrees from the leading edge vertical axis 305 mm above the **rudder datum point**.
- (b) Cutouts and recesses are allowed to a max of 30 mm provided there is 140 mm of material in any cross section from the datum point to 305mm above it. Only two inflection points are allowed in the cutouts.

Section F - Rig

F.1 RULES

- (a) **Rigs** shall comply with these **class rules**.

F.2 MANUFACTURERS

- (a) The manufacturer is optional.

F.3 MAST

F.3.1 DEFINITIONS

The **mast datum point** is the projection of the **sheer** on the **mast**

F.3.2 MATERIALS

- (a) For the construction of the **mast** only wood or aluminium alloy with minimum mechanical characteristics of 6061T6 is permitted. The **mast** may be anodized or painted.

F.3.3 WEIGHTS

	minimum	maximum
Mast spar weight including whiskerpole fitting Corrector weights .	9,1 kg	100 g

F.3.4 DIMENSIONS

	minimum	maximum
From the heel point to the upper point		6499 mm
Mainsail luff mast distance		5112 mm
Standing rigging and jib halyard rigging point above the heel point	4860 mm	4962 mm
Transverse dimension at the upper point	32 mm	
From the mast centre of gravity to the upper point		3588mm

F.3.5 LIMITATIONS

- (a) **Mast spars** having a transverse dimension of 54 mm or less shall have spreaders.
- (b) Rotating **masts** are prohibited
- (c) Any taper in the **mast** shall be above the forestay **rigging point** and shall be essentially a uniform taper.
- (d) Reinforcements may be added to the **mast spars** as long as they comply with these **class rules**.

F.4 BOOM

F.4.1 MATERIALS

- (a) For the construction of the **boom** only wood or aluminium alloy with minimum mechanical characteristics of 6063T6 is permitted. The **boom** may be anodized or painted.

F.4.2 DIMENSIONS

	minimum	maximum
Outer point distance		2559 mm
Total length from aft edge of the mast spar		2642 mm
Boom spar cross section:		
WOODEN BOOM		
Vertical	89 mm	102 mm
Transverse	19 mm	76 mm
ALUMINIUM BOOM		
Vertical	63 mm	102 mm
Transverse	22 mm	76 mm
Boom cut off external angles at extremities		45°
Sail slot cut away		
At fore end		350 mm from forward end of boom toward aft end
At aft end		From the aft end of the limiting mark to the end of the boom including any fitting

F.4.3 LIMITATIONS

(a) **Booms** shall not be tapered.

F.5 WHISKERPOLE

F.5.1 MATERIALS

(a) Any wood or aluminium alloy is permitted for the manufacturing of the **whiskerpole**. The **whiskerpole** may be anodized or painted.

F.5.2 DIMENSIONS

	minimum	maximum
Length		2642 mm

F.6 STANDING RIGGING

F.6.1 MATERIALS

(a) **Standing Rigging** may be made with any wire or rod.

F.6.2 DIMENSIONS

	minimum	maximum
Forestay diameter	2.5 mm	

F.6.3 SHROUDS

- (a) Any shroud adjusters that do not allow the manual adjustment of the shrouds with the rig under tension
- (b) Telltales are allowed

F.7 RUNNING RIGGING

F.7.1 MATERIALS

- (a) Materials are optional except differently stated in rule F.7.1(b) and (c).
- (b) Exotic materials may be used in **running rigging** fittings including the controls listed in F.7.2.
- (c) **Halyards** shall be made out of metal or fibre lines excluding PBO and carbon.

F.7.2 OPTIONAL

- (a) **Halyard** winches or tensioners.
- (b) **Mainsail** sheet blocks, fairleads and cleats.
- (c) **Mainsail** Cunningham blocks, fairleads and cleats.
- (d) Mainsheet bridle type and position is free.
- (e) **Headsail** sheet blocks, fairleads and cleats.
- (f) **Headsail** Cunningham blocks, fairleads and cleats.
- (g) **Headsail** Barber hauler fairleads, blocks and cleats.
- (h) **Boom vang** exercising downward force only, providing it is attached to the **mast** below the gooseneck
- (i) Any hiking straps or any kind of line or cord attached to the **boat** within 203 mm of the top of the deck. The location and number of hiking straps is free.

Section G - Sails

G.1 PARTS

G.1.1 MANDATORY

- (a) **Mainsail**
- (b) Jib

G.2 GENERAL

G.2.1 RULES

- (a) **Sails** shall comply with the **class rules** in force at the time of manufacture

G.2.2 CERTIFICATION

- (a) No certification is issued for Sails

G.2.3 DEFINITIONS

- (a) The ERS definitions shall apply.

G.2.4 SAILMAKERS

- (a) Sailmaker is optional.
- (b) A stamp shall be imprinted by the sailmaker at the top of the **mainsail** and **jib** to identify the weight of the sailcloth and the date of manufacture.

G.2.5 MATERIALS

- (a) Any type of woven polyester fabric or polyester film/scrim three **ply laminated** material shall be used as long it has a minimum weight of 130 g/sqm for the **mainsail** and 160 g/sqm for the jib. **Laminated** ply materials approval is limited to commercially manufactured, readily available materials with **woven** ply materials and which have been specifically approved by SCIRA on a case-by-case basis. See Part III.H.6 for the complete list
- (b) **Windows** of any non-woven predominantly transparent ply.

G.2.6 CONSTRUCTION

- (a) The construction shall be **soft sail**.
- (b) The following are permitted: **Seams**, stitching, glues, tapes, **tabling**, **primary reinforcement**, **secondary reinforcement**, corner eyes, Cunningham eye or block, **flutter patches**, Velcro fastening, tell tales, sail shape indicator stripes, sail identification, sailmaker labels.
- (c) **Sail** panels may be seamed or glued.
- (d) **Windows** may be added in each **sail** with a maximum **window ply** area of 0.2 sq. m. per **sail**.
- (e) **Leeches** shall have **tabling**

G.3 MAINSAIL

G.3.1 CONSTRUCTION

- (a) The top of the **mainsail** may be reinforced with a headboard, **tabling** or alternative methods not exceeding the **sail** top dimension.
- (b) A maximum of three **batten pockets** are allowed in the **mainsail**. The inside length of a **batten pocket** shall be not more than 38mm the length of the batten. The **mainsail leech** shape shall be straight or **hollow**.
- (c) Bolt ropes shall be even with the cloth at **mainsail head point** and **clew point**.
- (d) Bolt ropes on **mainsail foot** and **luff** may be cut off at tack no more than 254 mm.

G.3.2 DIMENSIONS

All dimensions are maximums unless otherwise noted. See diagram at H.6

Description	Length
Top Width	185mm
Three-Quarter Width	1059mm
Half Width	1755mm
Quarter Width	2245mm
Leech Length	5400mm
Top batten	457mm
Top batten pocket	Centre of batten pocket +/- 36mm to Three-quarter leech point
Centre batten	686mm
Centre batten pocket	Centre of batten pocket +/- 46mm to half leech point
Lower batten	610mm
Lower batten pocket	Centre of batten pocket +/- 60mm to Quarter leech point
Flutter patch	215 mm

G.3.3 MEASUREMENT

- (a) **Mainsail** battens shall be in place.

G.4 JIB

G.4.1 CONSTRUCTION

- (a) The jib **leech** and **foot** roaches shall be a single curve.

G.4.2 DIMENSIONS

All dimensions are maximums unless otherwise noted. See diagram at H.6

Description	Length
Top Width	30mm
Upper Luff Point	155mm
Upper Leech Point	155mm
Distance between Upper Luff Point and Upper Leech Point	115mm
Half Width	1025mm
Luff Length	3770mm
Leech Length	3545mm
Foot Length	2006mm
Foot Median	3725mm
Flutter patch	215 mm

Part III – APPENDIX

Section H – Figures

H1 HULL DIMENSIONS

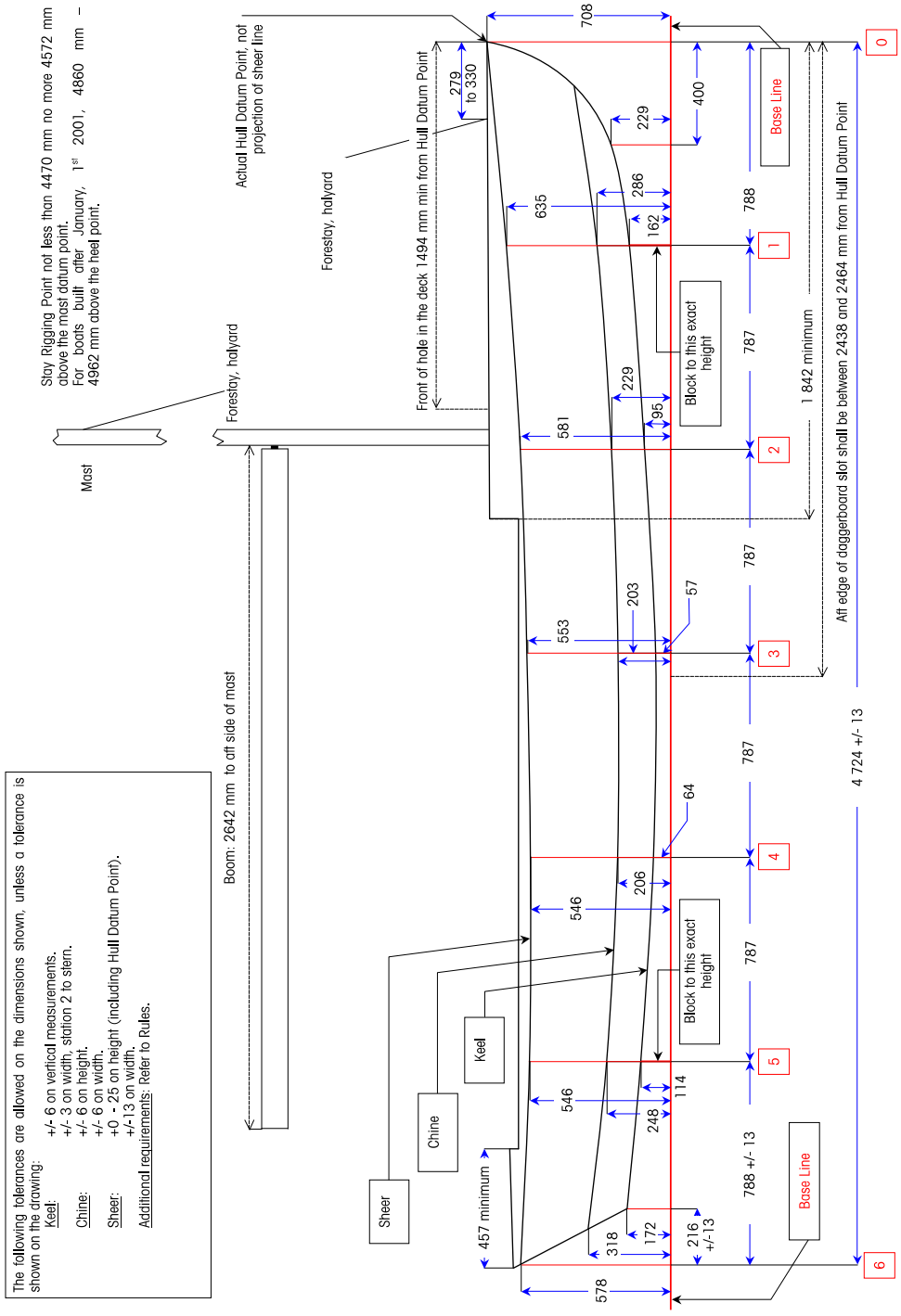

The following tolerances are allowed on the dimensions shown, unless a tolerance is shown on the drawing:

- Keel:** +/- 6 on vertical measurements.
- +/- 3 on width, station 2 to stem.
- +/- 6 on height.
- Chine:** +/- 6 on height.
- +/- 6 on width.
- Sheer:** +0 - 25 on height (including Hull Datum Point).
- +/- 13 on width.

Additional requirements: Refer to Rules.

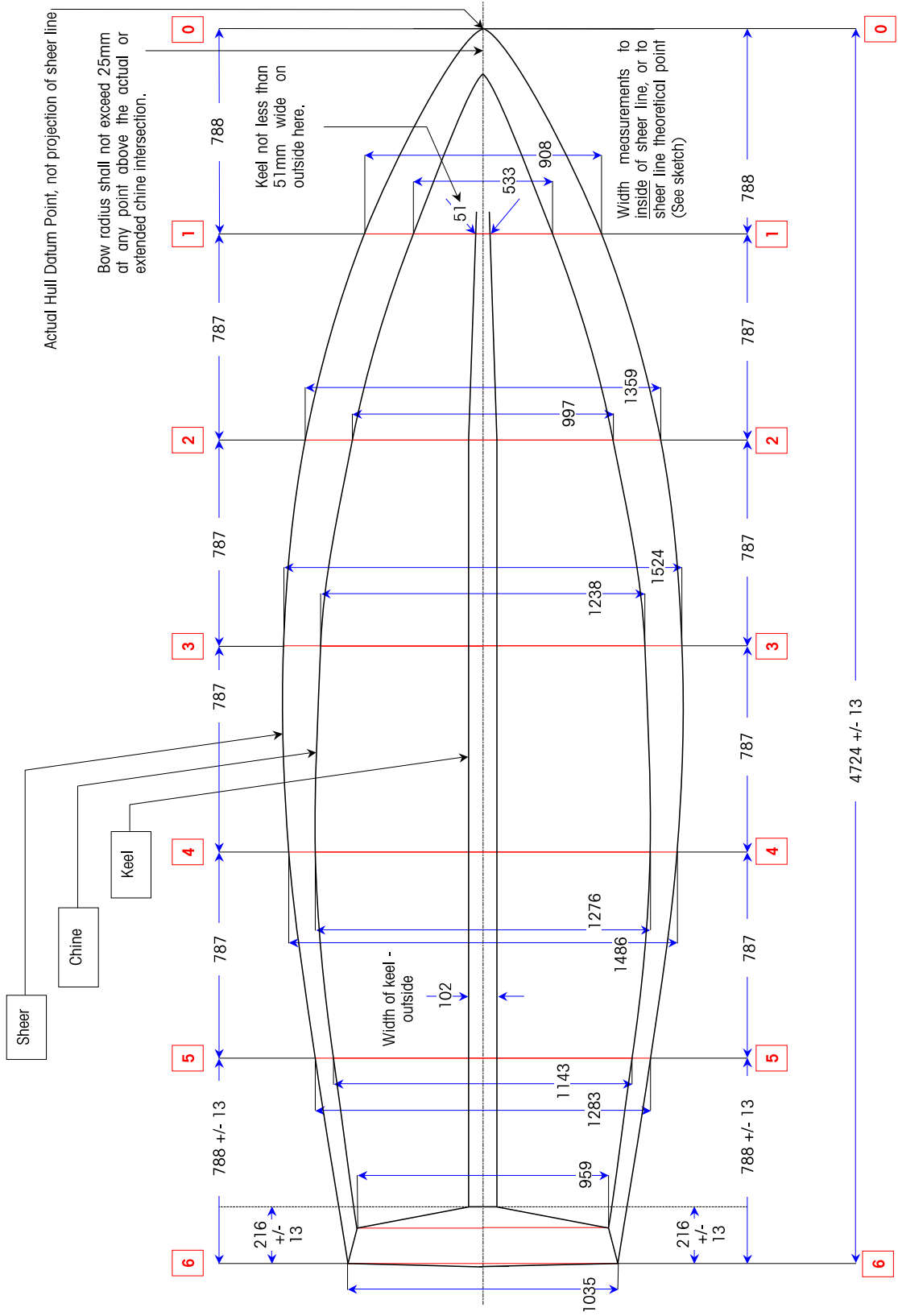

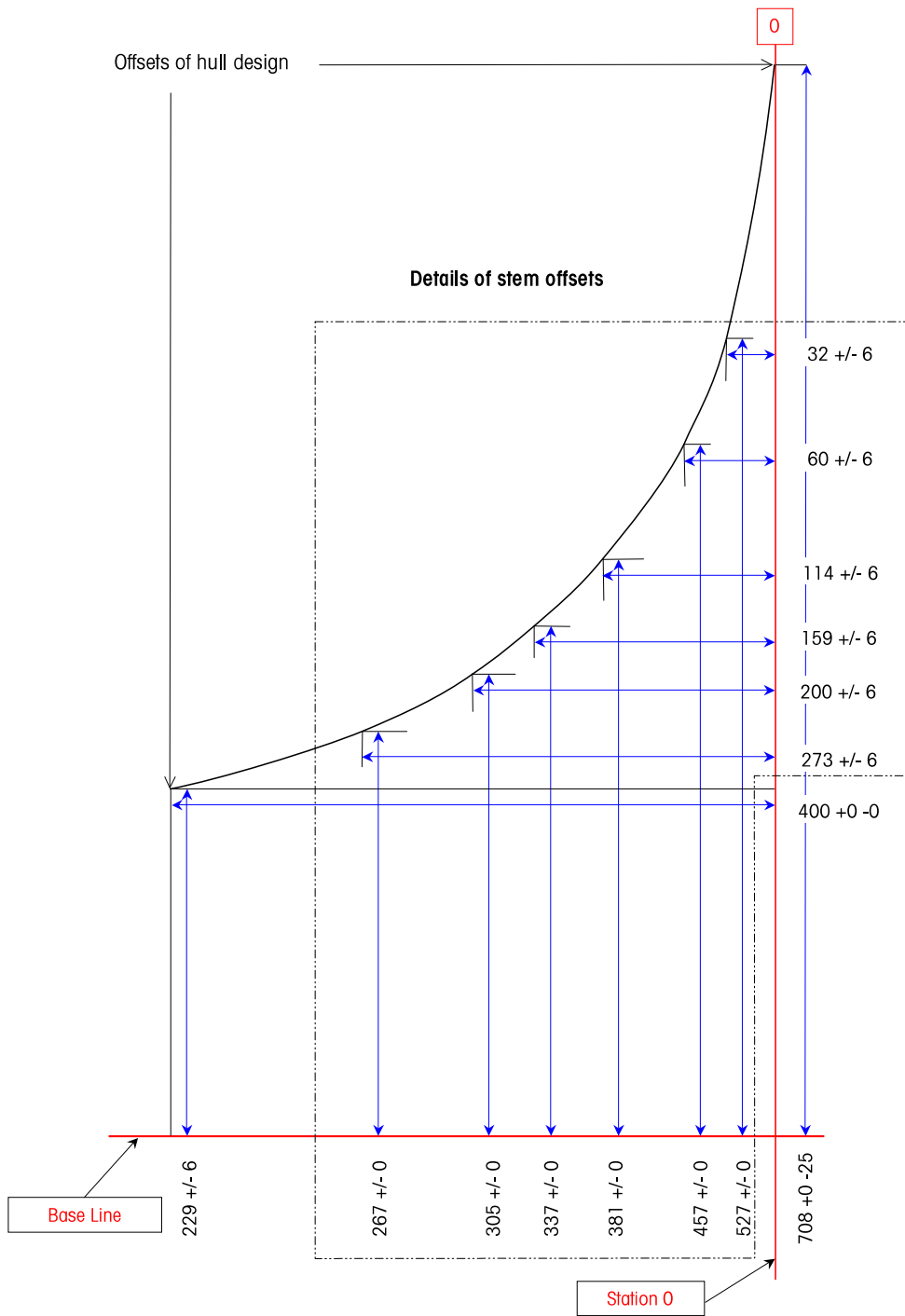

The intersection between the chine extension and the stem head shall be between 311 and 387 mm up from the base line.

H.2 GUNWHALE AND SHEER STRAKES

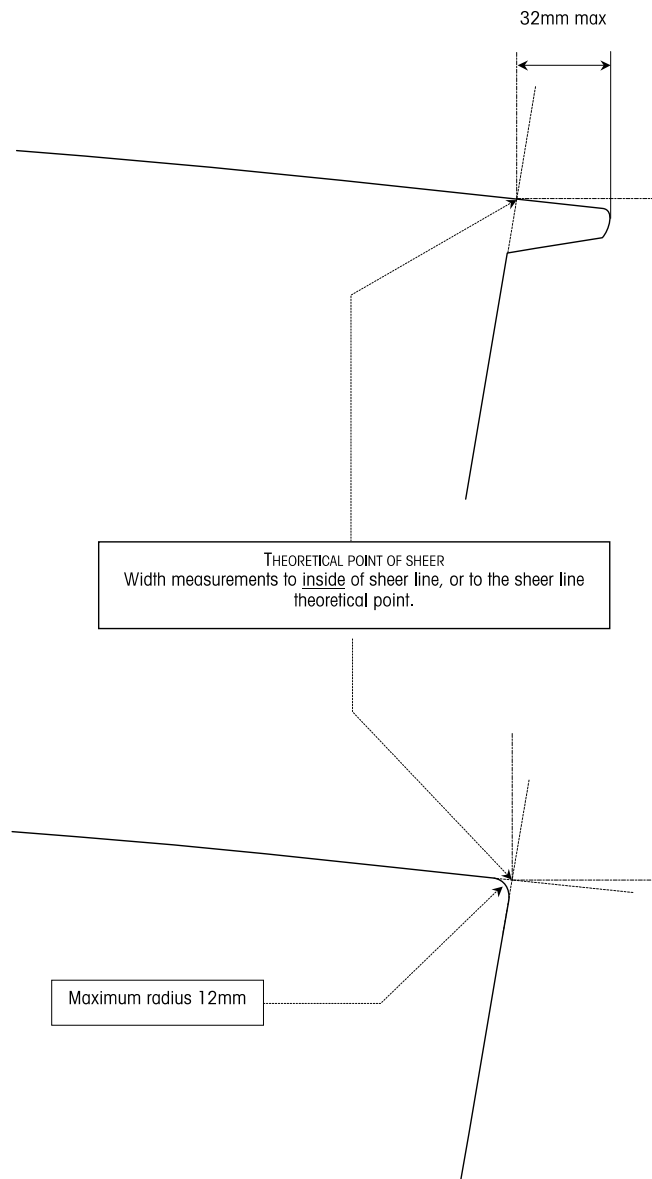

H.3 MOMENT OF INERTIA

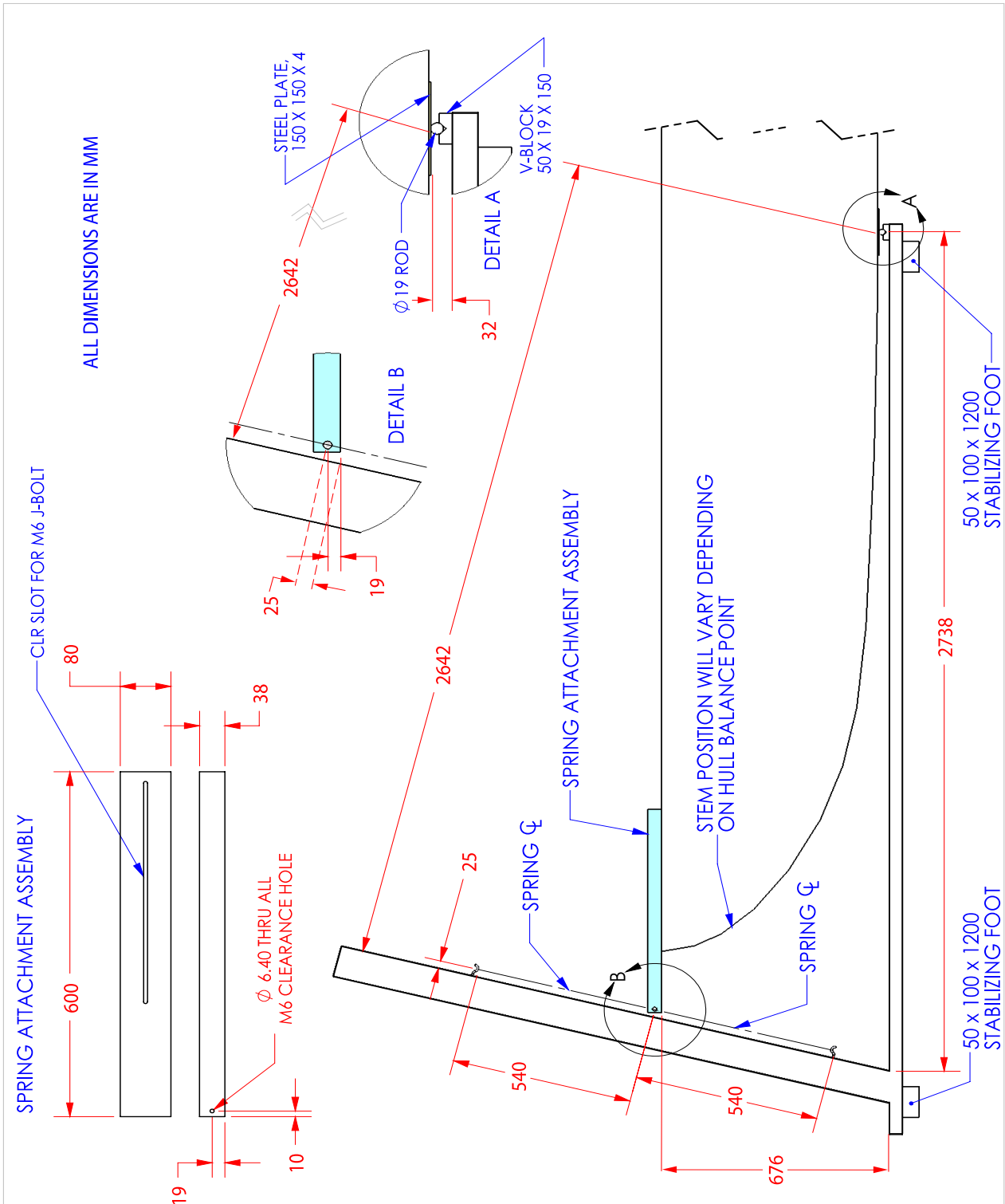

INSTRUCTIONS FOR THE MOMENT OF INERTIA

Set the moment of inertia jig up on a hard level surface and check to see that it is reasonably level both lengthways and sideways. Also check the 2642mm dimension from the aft side of the riser to the front side of the 19mm dia. balance rod.

Carefully balance the hull by moving it back and forth on the balance rod so that the top of the deck is level with the horizontal line on the riser. Be sure to use a thin metal plate (152x152x3mm is recommended) between the balance rod and the keel. Also the spring attachment assembly minus springs should be in position on the fore deck. When the hull is balanced, attach the springs to the spring attachment assembly and then to the hooks on the riser, being careful to stabilize the hull while doing this operation. Adjust the spring attachment assembly so that the centreline of the spring bolt is 25mm from the aft side of the riser and clamp the assembly to the deck with the hook bolt through one of the holes in the forestay fitting. Recheck to see that the Hull Datum Point is level with the horizontal line within plus or minus 6mm and adjust the hull position if necessary.

The hull should now be free to oscillate about the pivot rod, being restrained only by the springs. Check this by displacing the bow approximately 76mm to 102mm above or below the horizontal and allowing it to oscillate. Please notice that an oscillation is one complete cycle, from starting point to farthest away point and back to starting point.

Proceed to time the hull oscillations through a minimum of 20 complete oscillations. Divide the total time by the number of oscillations to arrive at the average time for one complete oscillation. Repeat this procedure twice to check that the average oscillation time is correct to the nearest thousandth of a second, starting with 76mm to 102mm bow displacement each time. Please note that the stopwatch is started at the beginning of the first oscillation but the number count is started at the end of the first oscillation.

Using the average time for one complete oscillation, solve the formula for moment of inertia.

H.4 DAGGERBOARD

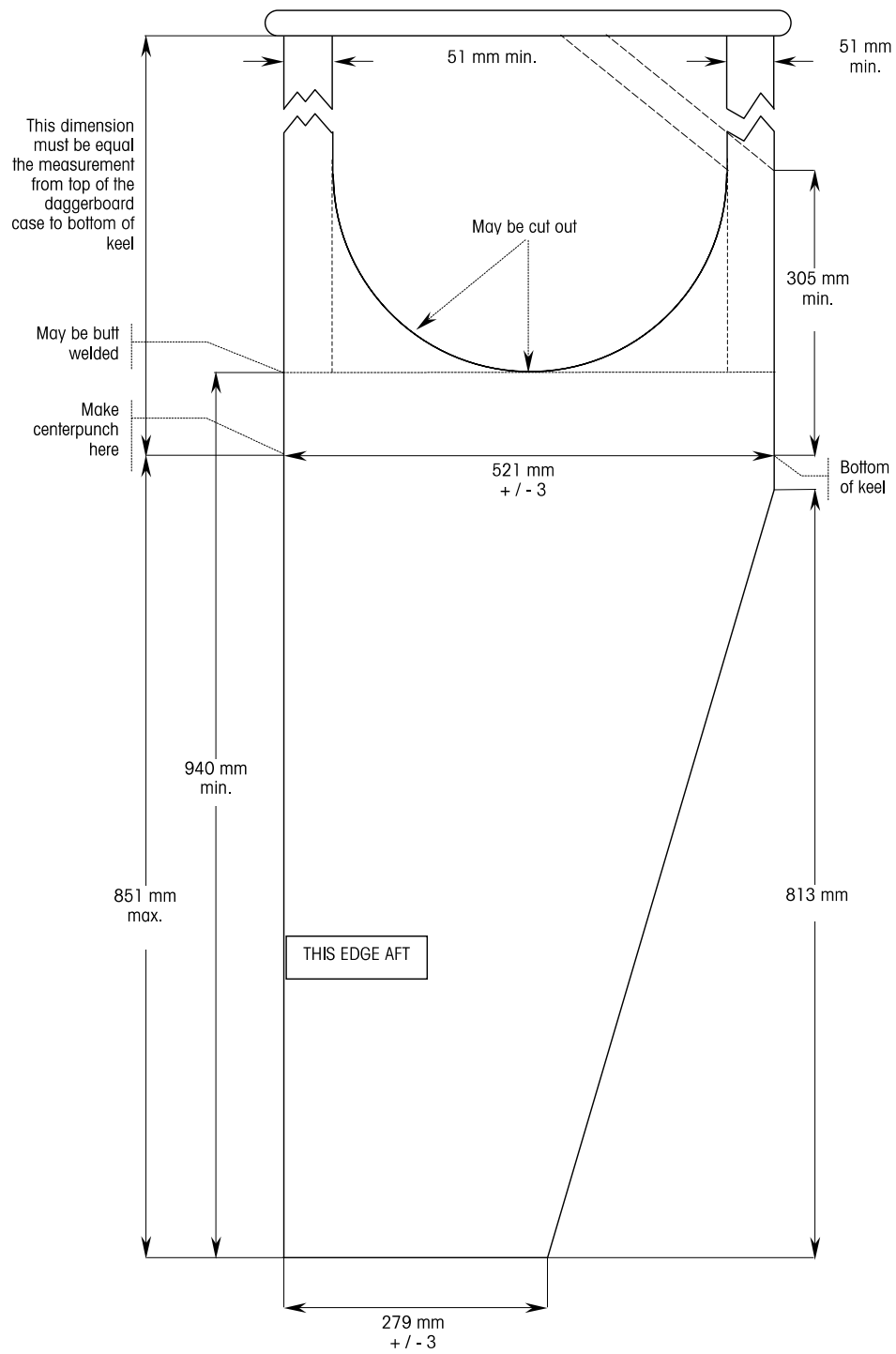

H.5 RUDDER

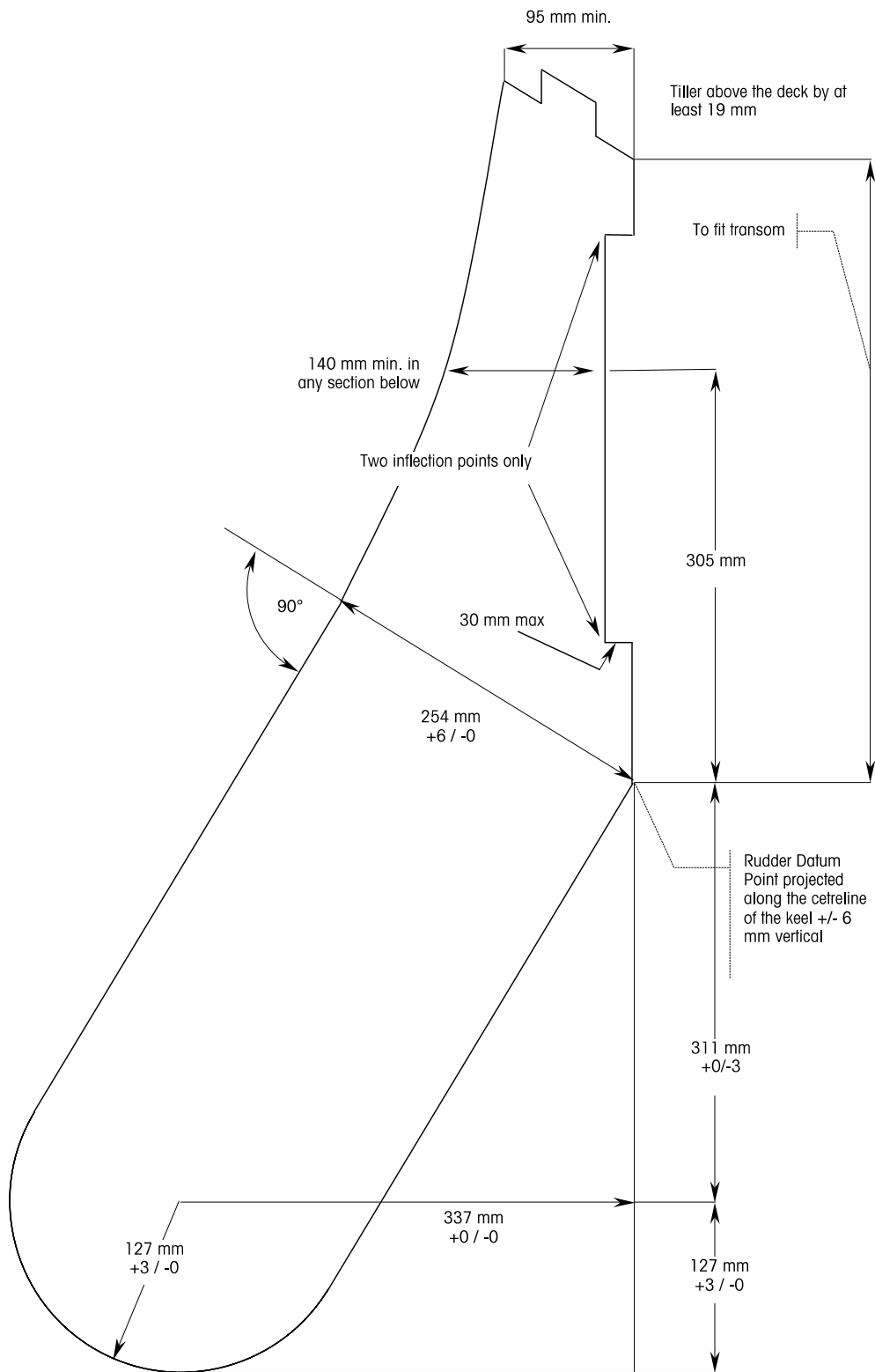

H.6 SAILS

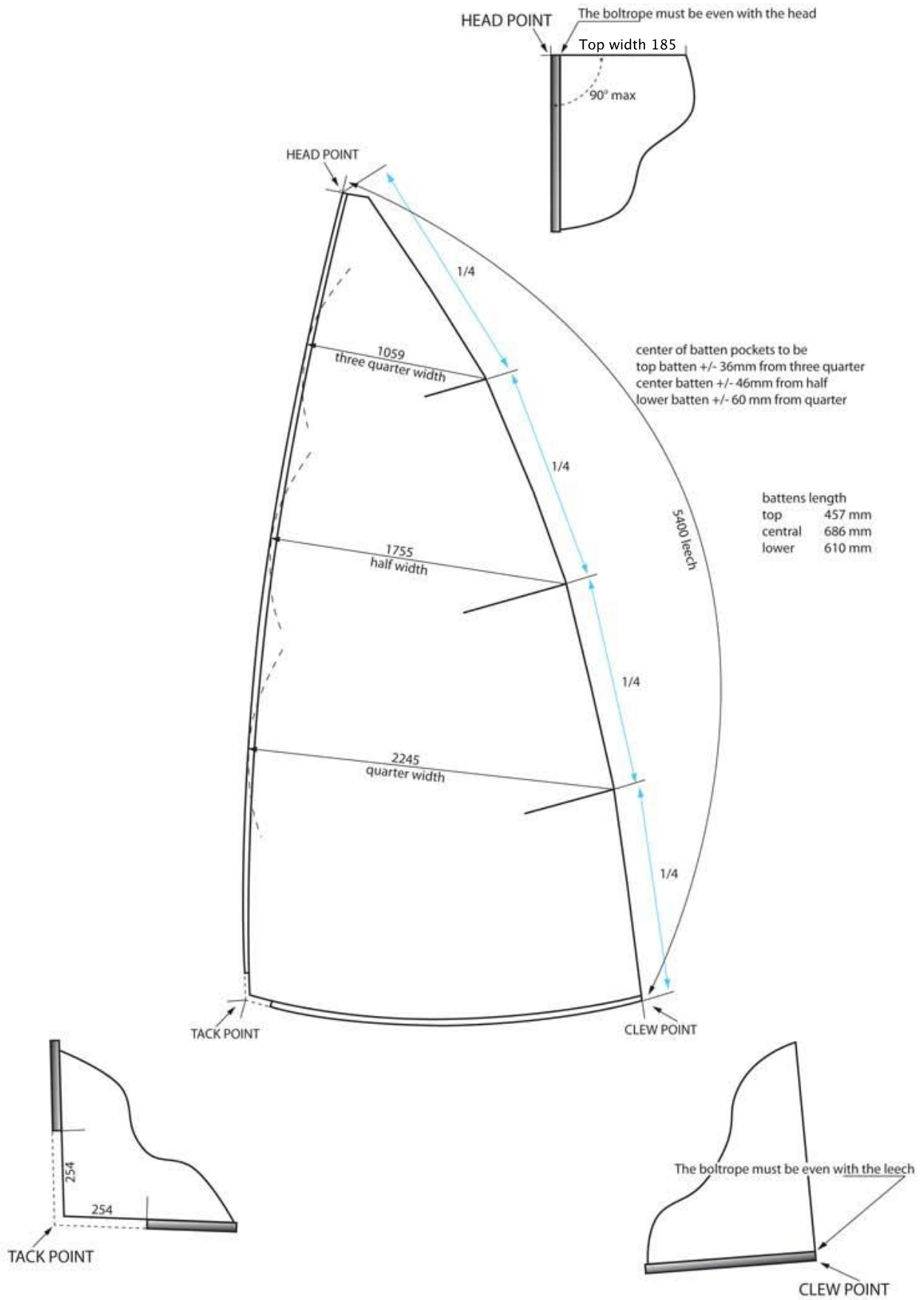

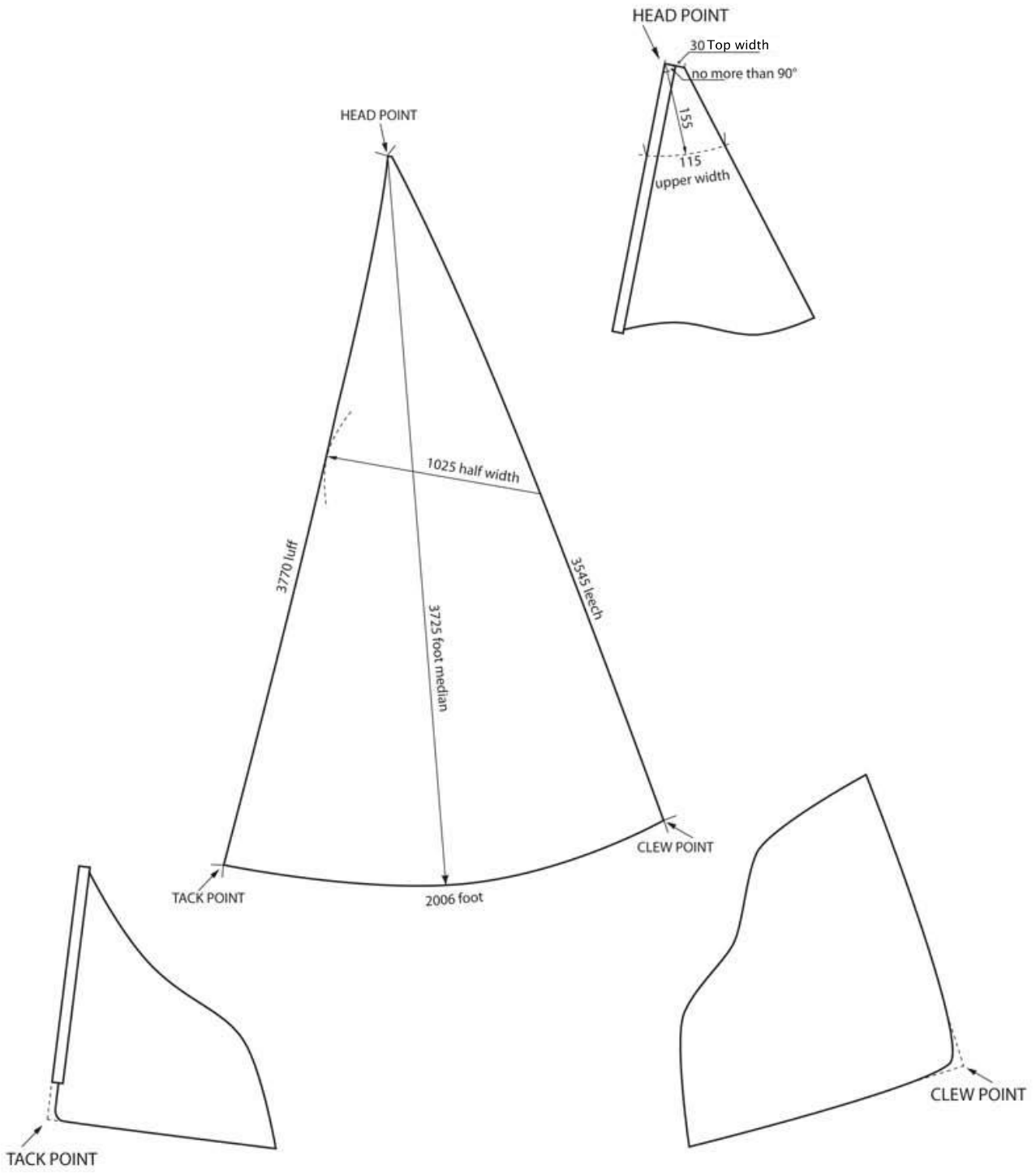

APPROVED MAILAR LAMINATES AS FROM JANUARY 1, 2021

For both sails **Contender ZYP13** (new)
 Bainbridge SL 1000P (no longer in production)
 Diax 60 P (not available in all countries)

For main only **Dimension Polyant PG45** (new)
 Dimension Polyant PM-05 (1.5 mil), formerly M 290 (no longer in production)

Effective: 01/07/2023

Previous issue:

01/01/2021

16/03/2020

26/07/2019

26/02/2018

01/03/2004