

International J/24
Class Association

MEASUREMENT
MANUAL

Effective April 2013

Revised April, 2013

TABLE OF CONTENTS

Topic	page
1.0 Introduction	4
2.0 Interpretations	6
3.0 Getting Ready.....	7
4.0 Hull and Keel Measurement	10
4.1 Equipment and personnel:.....	10
4.2 Preliminary setup measurements:.....	10
4.3 Part 'D' measurements	10
5.0 Rig Measurement	23
5.1 Part 'D' measurements.....	23
5.2 Table of rigging Power ratios.....	26
6.0 Deck and Cabin Items	29
7.0 Sail Measurement.....	31
Introduction	31
7.1.0 Site and Layout.....	31
7.2.0 General Information.....	33
7.2.1 PRINCIPLES OF SAIL MEASUREMENT	32
7.2.2 REINFORCEMENT	32
7.2.3 ADVERTISING MARKS	32
7.2.4 ROYALTY TAG LOCATION.....	32
7.2.5 Signing sails	32
7.3.0 Procedures for Sail Measurement.....	33
7.3.1 MAIN SAIL MEASUREMENT PROCEDURE	33
7.3.2 JIB MEASUREMENT PROCEDURE	34
7.3.3 GENOA MEASUREMENT PROCEDURE	34
7.3.4 SPINNAKER MEASUREMENT PROCEDURE	34
8.0 Weigh In.....	40
8.1 Preparation of Boat Weighing Equipment.....	40
8.2 Boat preparation.....	40
8.3 Boat weighing process.....	40
8.4 Crewing weighing process.....	41
Appendix A Sail Measurement Floor Layout.....	42
A.1.0 Introduction.....	42
A.1.2 Site Selection.....	42
A.1.3 Getting Started.....	42
A.1.4 Materials and Equipment.....	42
A.1.5 Personnel requirements.....	42
A.1.6 Masking tape identification marks.....	44
A.2.0 Mainsail Layout.....	45
A.3.0 Jib and Genoa Layout.....	50
A.4.0 Spinnaker Layout.....	53
Appendix B Alternate Sail Measurement Method.....	56
MEASUREMENT FORM.....	57

Amendments

Version	Date	Affected areas
A	Dec 1998	
B	Dec, 1999	
C	Sept. 2000	
D	May, 2001	Updated to latest class rules
E	May, 2002	Sect. 3, 6
F	July, 2002	All sections re-numbered, Interpretations added, Appendix A updated
G	Aug. 2002	Added drawings of keel marking battens; changed Interpretation 2.5; 4.2.3; 4.3 items 2, 2a, 3, and 4; fig 4; and fig 4.6, corrected item 3 to 3a, & 3b.
H	Oct. 2002	Modified mainsail tape layout
H ₁	Oct. 2002	Section 3.3: eliminated reference to "B above"; Sec.4.3.9 & 4.3.10: Changed 'fig 3.5' to 'fig 3.0'; Dwg. 3.0.a: referenced hole detail; added '+/-' to 10mm tolerance in 4.3.10.
J	May, 2003	Rudder drawing (page 16) revised to clarify transom parallelism requirement
J ₁	May, 2003	Revised keel batten drawings to show the correct values for the Trailing Edge batten. (page 8). Added Note #3 to Item #5 on page 11
J ₂	May, 2003	Updated cover sheet to 2003-2004 class rules
J ₃	June, 2003	Added note #6 to Item #4 on page 11.
K ₁	Mar. 2004	Added keel bottom reference dimension.
L ₁	May, 2005	Clarified keel bottom vee and reference of parallelism of keel sections to keel bottom.
M	Feb. 2006	Added keel vee angle limitation of 90 degrees maximum. Item #5 & Dwg. 4.1.11 Added measurement forms at end
N	Jan. 2007	Revised drawing of Jib and Genoa floor layout (appendix A) to correct depiction of head point. Changed wording of A.3.1 to note head point is perpendicular to the luff.

O	Feb 2007	Added Appendix B 'Alternate Sail Measurement Method'. Also added an alternate floor layout for the jib and genoa sails.
P	April 2007	Added note to page 22 describing the need to check the deck shear abreast the mast for any dip
Q	June 2010	Added transom drawing to page 11 defining the measurement for convex transoms. Modified wording for clarification. Changed ITEM wording to agree with Measurement Form. Added Measurer Reference Notes for items not explicit in the class rules.
R	Apr 2011	Rudder depth from transom corner corrected to 860mm to 880mm.
S	Mar 2013	Removed Table 5.2 Minimum Rigging Diameters. Changed Table 5.3 to 5.2. Changed Measurement Form effective date to 1 April 2013. Changed Part C All Up Weight to 1330 KG

Notice:

The intention of this manual is to assist class certified measurers and is to be used in conjunction with the current class rules.

These procedures are subject to future revisions that may affect rule interpretation.

If you are not a current class certified measurer and intend to use information in this document to make repairs or changes to a boat, you are advised to consult a class certified measurer before starting work on the project. Occasionally errors and omissions are found therein that could lead to misinterpretations.

I. Introduction

Rodney S. Johnstone hand-built the first J/24 in his garage. It was launched on May 15, 1976 in Stonington, Connecticut. The first sailing season was such a success that Rod consulted with Everett Pearson (now TPI) to build a mould and begin production. Hull number 2 was launched in March, 1977, the Class was formed April 12, 1978, and the IYRU confirmed International status in June, 1981.

The fundamental difference between the J/24 Class and most other International One Design Classes is that the copyright holder controls hull shape through the mould, not a set of line drawings. Moulds built after August 2, 1993 must be inspected and approved, at the builder's site, by a member of the IJCA Technical Committee (appointed by the IJCA Executive Committee), before being put to use.

Had Rod known that production would eventually exceed 5,000 hulls, he probably would have made sure the original was symmetrical and fair before Pearson splashed the first mould. The third or fourth hull out of the mould was cross-braced to prevent distortion, and became the master plug from which future moulds would be built. It is understandable that the same imperfections and asymmetry of the hand-build original are with us today.

As J/Boats licensed builders in Europe, South America and Japan, Pearson provided moulds from the master plug. Hulls are built in many different countries and climates. The availability of raw materials and building conditions may not be quite the same as in Pearson's Rhode Island facility, but J/Boats has worked hard to maintain the same integrity and weight distribution. The plus or minus tolerances in the Class Rules are to accommodate variations from builder to builder (see Rule 2.7.5).

The J/24 is almost indestructible. Its hull is made of a sandwich of 3/8" end grain balsa wood covered on both sides with two or three layers of fiberglass cloth, resin and gelcoat. The deck is a similar lamination, using 1/2" end grain balsa core. When repairs involve rebuilding or replacing gelcoat surface, refer to the Hull Lamination Details to comply with Rule 3.1.2.

Until very recently the hulls were made in two halves, and glued down the center seam. The interior liner is then set in place, and the deck is sealed and attached. Interior layouts will vary depending on the vintage and nationality of the builder. The weight distribution is thought to be the same even though the look is different. Prior to the 1997-1998 class rules, it was a requirement that the interior layout must comply with what was delivered from the builder, even if repairs were made. The current rules allow the interior to conform to the current builders specifications in order to allow owners to update their boats to the latest approved materials and configuration.

A new era for the J/24 Class began in 1989 when 40 IYRU approved rule changes became effective. This was a milestone because the new rules addressed ways to correct improper hull and keel refinements, as well as setting new definitions for uniform fore triangles (mast height) and boat weight.

Boat owners have worked hard to perfect their hand-built production boats. It is this desire for perfection that must sometimes be held in check.

The present definition of the keel is slightly different from the early Rules which showed the top of the keel to be at the fairbody. The fiberglass portion of the keel (referred to as the "stub") extends down to just above Section I, and is actually part of the molded hull. Today the keel is defined as beginning at Section I. The stub is not symmetrical. Before the definition was clarified, many keel fairing jobs included a symmetry correction to the stub. Since this is part of the molded hull, it may not be altered. When this violation was discovered, Rod defined a point on the stub (commonly known as the "Johnstone bump") that must be no less than 185mm thick, and fair in all directions. The location is not in the Rules, but is listed as Item 6b on Part D of the Measurement Form.

Rule 3.2.1 allows for the center seam to be faired so long as the contours are not changed. There have been cases where the center seam has been built up and faired to a sharper than normal "V", just below the bow. The correction is to round the seam so that it has the average shape of ten other hulls that have never been touched (Rule 3.1.3). Bow shapes will vary depending on the way the halves were joined together, or a hull that came from a one piece mould. These variations are minor, and no shape is known to be either an advantage or a disadvantage.

Because the class does not have use of the builders drawings, the boat measurement process has been subject to variations in technique that required rule interpretations. This manual will be updated to reflect the current class rules and is intended to minimize those variations and remove ambiguity from the process.

Safety in Measuring

Measurement is usually done with the boat sitting on the trailer. Exceptions are that weighing the boat requires lifting the boat clear of any trailer supports, and some trailer structures require that the keel be measured with the boat lifted clear of these structures.

Weighing – This is usually done by lifting the boat clear of the trailer but still directly over the trailer and the support pads. If a boat falls from this position due to failure of the lifting gear, it is usually not catastrophic. Stay out from under the boat, and keep out of the space between the boat and the trailer support pads.

Measuring keels under a lifted boat – This is done because trailer structure prevents access to the keel for measurement. If the structure is bolted on, as are some float-off guides, have the structure removed to allow access to the keel while the boat is on the trailer. If you must go under a lifted boat for measurements of the keel, inspect the lifting rig before the boat is lifted and minimize the time you spend under a lifted boat. If possible, keep the trailer partially under the boat so that if the lifting rig fails and the boat drops, the trailer may still function to protect the measurement crew under the boat. If there are questions about the depth of the keel or the shape of the bottom of the keel, the only way to get these measurements is by lifting the boat. We do not usually check these measurements unless the keel depth looks to be too long on the trailing edge or the V shape appears to be too flat by observation when the boat is lifted for weight. It is recommended that the boat keel be set on a heavy wooden block while hanging free of the trailer.

2. Interpretations:

The subject of measurement has developed into a more complex and critical aspect than originally contemplated. Today, many yachts are modified to one end of a listed tolerance to achieve a performance advantage (real or perceived). This has placed added importance on the ability of measurers to accurately assess the borderline situations and not accept a nonconforming characteristic or conversely, reject a conforming characteristic.

In order to clarify the meaning of terms frequently used in the measurement process, the following is a list of interpretations:

- 2.1.** "Acceptable"- means a generally accepted practice or value when readings are not at the extremes of the tolerance
- 2.2.** "Preferred"- means a practice or dimension that reflects a desired condition and to provide additional confidence when a characteristic is very close to the minimum or maximum permitted dimension.
- 2.3.** "Referee"- refers to obtaining consensus if there's any question regarding the compliance of a practice, characteristic, or dimension. This can be accomplished by surveying a random sample of 10 boats to provide a comparison.
- 2.4.** "+ / -" means plus or minus, not both. As an example: '+ / - 5mm' means plus 5mm or minus 5mm, not a total of 10mm.
- 2.5.** The keel stub is part of the Hull Molding and may not be reshaped. Refer to Class Rules 3.1.3, 3.2.2, and 3.2.8a&b

3.0 Getting Ready

MEASUREMENT EQUIPMENT

The purpose of this section is to describe the measurement equipment that is required to perform the measurements of each element of the class rules in PART D

3.1) 10 meter tape measure - should be of durable construction, accurately made, and of *metal*. Verify accuracy of tape end by comparing to meter rule in both tension and compression (if applicable). Caution must be exercised as measurement errors can result depending upon the type of end on the tape. Some are intentionally manufactured with slack in the end to compensate for the tab thickness when making either inside or outside measurements.

Most measurements are made with tape measures or scales and the actual readings recorded in Part D.

3.2) 1 meter rule- permits some measurements to be made by one person. Also doubles as a straight edge.

3.3) Straight edge- if a meter rule is not available, you will need this for the straightness measurements.

3.4) Class Keel Templates- the official gage to check keels to the Keel Plan (Plan C).

3.5) Calipers / no-go gages- Adjustable calipers or constructed no-go gages are required to check several characteristics as noted in the Tables. A "no-go gage" is typically a "U" shaped template whose inside dimension at the opening is accurately made to the dimension to be checked. Thus if the dimension is acceptable, the gage won't "go". See Figure 3.0 for examples.

3.6) Class scales- the official method for weighing the yacht. Note that the scales must be re---certified on an annual basis.

3.7) 20kg scale- required to weigh lighter items with improved accuracy.

3.8) Class Trailing Edge & 2mm radius gages (TEG) - this multipurpose gage can check several characteristics and is a "no-go" gage.

3.9) Mast jig- a tool to establish the 400mm dimension in Plan B.

3.10) Permanent Marking Device - a knife, file or center punch that can discreetly mark the mast.

3.11) Keel marking fixtures - fiberglass batten material with holes located to enable marking the keel template locations. A scoop in the top edge of the leading edge marking fixture will help to accommodate the sweep that is usually present in the transition from the fairbody into the sump. Refer to Fig 3.0.a.

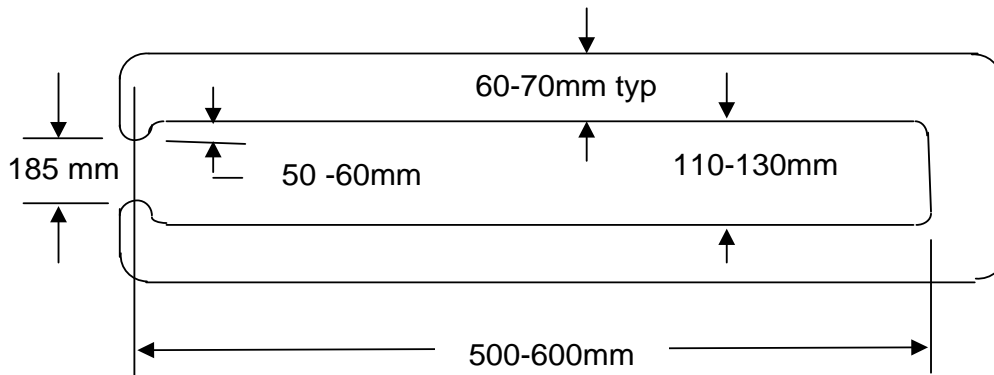

Keel Stub Measurement Fixture
 1/4 aluminum or equiv
 ('J Bump fixture)

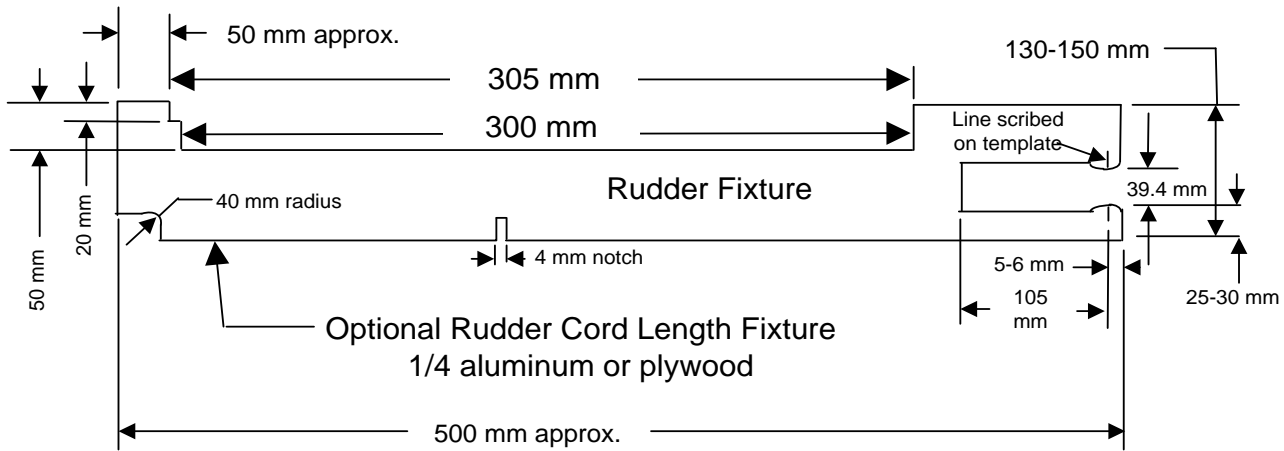

Keel and Rudder Measurement Fixtures
Fig. 3.0

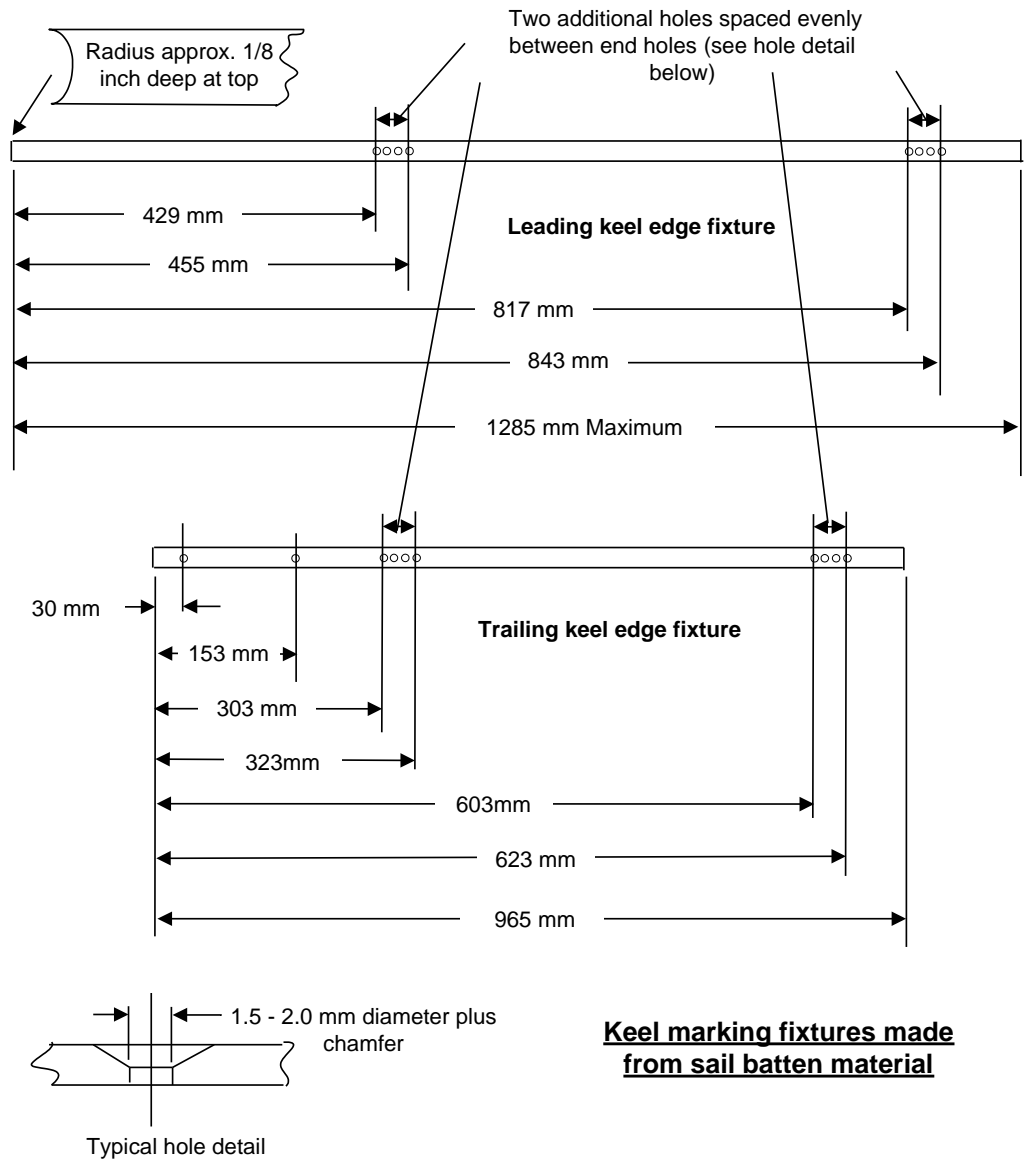

Keel and Rudder Measurement Fixtures
Fig 3.0.a

4.0 Hull and Keel Measurement

4.1 Equipment (if only measuring keels and rudders part of Section 3):

1. J-24 Class keel templates & keel and rudder measurement fixtures
2. 10 metre metal tape measure
3. 1 metre rule
4. Marking pen or pencil
5. Flexible batten or straightedge for measuring keel fairness
6. J-24 class Measurement form
7. Weight scale (or handheld scale) capable of 20Kg measurement.
8. Trailing Edge Gage (TEG)
9. "J" bump Template to enable measurement of 185mm keel stub dimension (see dwg.4.1.11 and Fig 3.0)
10. Rudder cord length fixture (see Fig 3.0).
11. Masking tape for marking hulls, etc.

4.2 Preliminary setup measurements:

1. Establish the intersection of the hull and the leading and trailing keel edges - see fig. 4.0. This is facilitated if the intersect is a sharp corner. If the intersect is rounded, extend the hull surface and keel trailing edge to identify that point that represents the effective point of intersection.
2. Measure down and mark the trailing keel edge at 303 mm and 603 mm from the hull intersect. Place an additional mark 20 mm below these marks. Divide the distance into thirds and mark. This will serve as an aid to positioning the templates evenly when measuring. See Fig 3.0a for keel marking fixture.
3. Measure down and mark the leading keel edge at 429 mm and 817 mm from this intersect. Then place additional marks at 453 mm and 843 mm. Divide the space between each set of marks into quarters. This will allow the templates to be evenly positioned with respect to the trailing edge marks.

Measurer Reference Note: The keel intersection is the best estimate of the leading edge and hull intersect. Above Station I this may not appear to be a straight line extension of the lower keel leading edge. If that is the case extend the leading edge below Station I until it touches the hull and use that point as the upper point of the leading edge template marks as indicated in item 3 above.

4.3 Part D Measurements:

ITEM #1 RULE 3.3.3.A

Corner of transom to trailing edge of keel at hull:

- Using the straightedge, establish the Transom Corner (see fig. 4.0) by placing the straightedge vertically on the transom center below the rudder gudgeon fitting (fig. 4.3.1b). Have an assistant hold the tape measure along the hull center so that it is a continuation of the hull surface as it intersects the straightedge. To ensure accuracy, place the 10 mm tape mark the straightedge and deduct 10 mm from the measurement reading.

Measurer Reference Note: Check that the transom has a slightly concave shape such that a straight edge, when laid on edge at the rudder gudgeons will contact the hull at the top and bottom edge of the transom and hull bottom (see the ‘Typical transom configuration’ drawing below). However, if the transom has a convex shape such that a straight edge contacts the lower transom surface approximately 70 – 200 mm above the lower edge (see Fig 4.3 below) Then the measurement to the trailing keel edge should be made where the extension of the hull bottom intersects the straight edge.

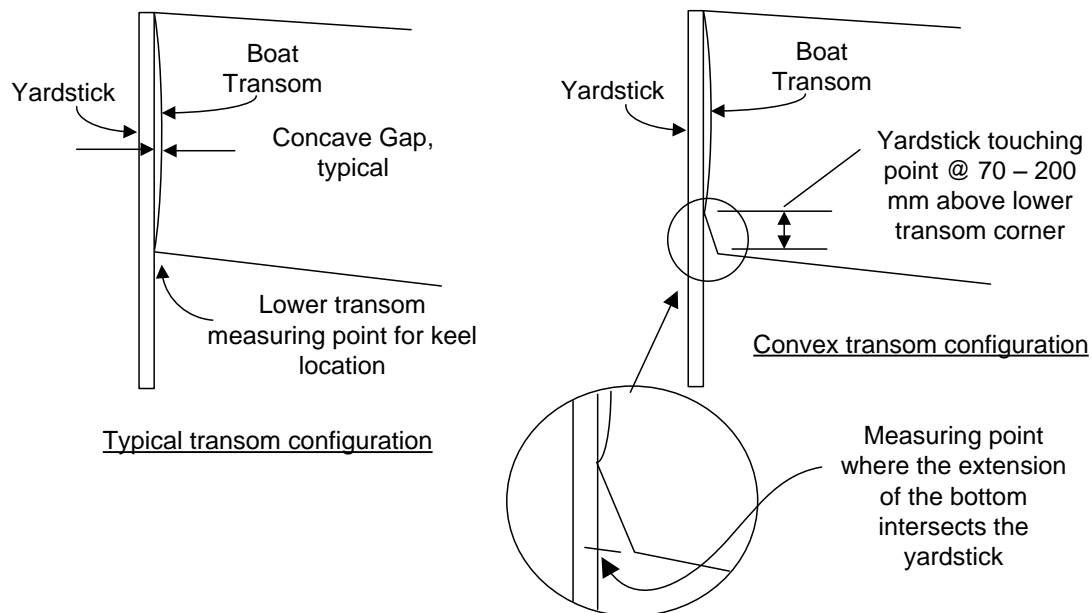

Fig 4.3

- Measure along the hull center to the trailing edge and record the dimension (2996 / 3020 mm).

ITEM #1a RULE 3.3.3.B

At 603mm down (section IV)

- Measure from the Transom Corner to the 603 mm mark on the keel trailing edge and record the dimension (3095 / 3125 mm).

ITEM #1b RULE 3.2.7

Radius of corner is 2mm or greater

Use the radius on the TEG to insure that the Transom Corner radius (see fig 4.0) is 2 mm or greater (YES/NO).

ITEM #2 RULE 3.3.4

Leading and trailing edges of keel between Sections I and VI are within +/- 5mm of a straight line. (YES/NO)

1. Verify that the leading and trailing edge is a faired surface fore, aft, and athwartships between the two sections. There should be no pattern of waviness, i.e. either smoothly convex or concave but not both. (YES/NO).

ITEM #2a RULE 3.3.2

Trailing edge of the keel does not exceed 965mm. (YES/NO)

1. Use a 965mm premeasured stick to verify that the trailing edge complies with the maximum dimension.

ITEM #3a RULE 3.3.2

Width of keel trailing edge at Section I: 12.8 mm or greater (YES/NO).

1. Use the TEG to verify that this is the minimum dimension at 153 mm below the hull (Station I. - see fig. 4.2).

ITEM #3b RULE 3.3.2

From Section II to VI: 3.6 mm or greater (YES/NO).

16. Use the TEG to verify that this is the minimum dimension at any point at or below Station II. (see fig. 4.2).

Measurer Reference Note: Some boats exhibit a rounded trailing edge. If this is the case the 3.6 mm dimension applies within 1 mm of the trailing edge,

ITEM #4 RULE 3.3.2

Does keel comply with minimum and maximum faired dimensions of plan C at Sections I-VI? (YES/NO).

1. Refer to section 4.2 for preliminary measurements to be made along the leading and trailing keel edges.
2. Using the class template for Station II, assemble around the keel. Two people will be needed to hold the templates. Position the template at the upper keel marks (see fig. 4.0 for location of Section II) and against the leading keel edge, check that the keel station length aligns with the forward part of the template cutout. (see fig. 4.6) If necessary, lower the template parallel to the upper keel marks, using the quartering marks as guides, until the trailing keel edge aligns with the front edge of the cutout. While holding the template at that position, slide the template against one side of the keel and insure that the gage pin will not pass through the scallop points on the template. If the pin does pass, identify the point or points with a marker and outline the zone of non-compliance.
3. Note: these templates are the only official keel shape gage. If the keel shape is too thick to allow the templates to be placed in position, note the cause and contact a member of the Technical Committee for further instructions.
4. Repeat instruction 2 above for the Station IV template.

5. Use the batten or straightedge as a fairing gauge to verify the vertical smoothness of the keel between Sections I and VI. There should be no significant hollows or other discontinuities.
6. **Measurer Reference Note:** The 13mm Keel Leading Edge radius is measured parallel to the template planes, not perpendicular to the leading edge surface.

ITEM #5 RULE 3.3.2

Do you believe the keel complies with the minimum and maximum faired dimensions of Plan C elsewhere? (YES/NO).

1. This is basically a continuation of Item 4, check for the vee section of Section A of Plan C.
2. Note the vee shape of the keel bottom (fig. 4.1.11). The included angle is a maximum of 90 degrees. Keels cannot be flat or nearly flat and must exhibit approximate conformance to the vee shape. The vee measurement check is to be made approximately 260mm forward of the trailing edge along the bottom of the keel. At this location the flat on the bottom should be between 10mm and 15mm wide. The bottom of the keel must not project below a line between 965mm from the hull fairbody at the trailing edge and 1285mm from the hull fairbody at the leading edge of the keel. The measurement should be made whenever keels are being measured or checked.
3. **Measurer Reference Note:** Although not specified in the rules, the design intention of the keel is that the bottom is perpendicular to the trailing edge. After ascertaining that the trailing edge does not exceed 965mm length, verify that the leading edge is no longer than 1285mm which is the calculated length when the keel is at maximum length. This is not currently a class rule dimension, merely a means of assuring the design intention. If the dimension is significantly greater, compare the findings to a sample of 10 boats before a decision to reject is made. Also note that if either the leading or trailing keel edge is shorter by 30mm or more then the vee section measurement can be ignored.
4. The corner of the trailing edge at the bottom of the keel should be relatively sharp (per Plan C) no more than 5mm radius.

ITEM #6a RULE 3.1.1

Hull profile width of molded keel stub at top of trailing edge, 22 mm or greater. (YES/NO).

1. Use the TEG to verify and record if the keel trailing edge at the hull intersect is 22mm or greater - see fig 4.2).

ITEM #6b RULE 3.1.1

At 19mm below fairbody, 760mm around the contour from 30mm down from the corner of the trailing edge, 185mm or greater. (see MM interpretation 2.5) (YES/NO).

1. This measurement requires a J-bump template capable of making the measurement approximately 500mm back from the leading keel edge at 19mm below the keel / hull intersect. (see fig. 4.1.11)

ITEM #7 RULE 3.4.3

Weight of rudder, tiller, extension, and fittings.

1. Weigh and record the rudder, tiller, fittings, and the lightest extension (if more than one is used). (13.5 kg minimum). Do not include the throwl pins.

ITEM #8a RULE 3.4.2

Width of rudder trailing edge 4mm or greater. (YES/NO).

1. Use the TEG to verify that the trailing edge is 4mm minimum over the 955mm length in Plan D see fig. 4.1.12b).

ITEM 8b RULE 3.4.2

Cord length of rudder between 300mm and 305mm. (YES/NO).

1. Use the rudder fixture described in fig. 3.0 to verify that the value range holds over the 955mm height in Plan D (see fig. 4.1.12b). Keep the templates perpendicular to the leading and trailing edges (shortest distance)

ITEM #8c RULE 3.1.1 & 3.4.2

Does rudder comply with minimum faired dimensions of Plan D (YES/NO).

1. Use the rudder fixture described in fig. 3.0 to verify that the minimum thickness of the rudder is not less than 39.4mm over the 955mm height and at 105 mm back from the leading edge. Check that the bottom corners have an approximately 40mm radius (see fig. 4.1.12b).

ITEM #9 RULE 3.1.1 & 3.4.2

The depth of the rudder measured between the rudder tip and transom. (860/890mm).

1. Placing the straightedge along the rudder tip (bottom edge), measure the distance from the Transom Corner parallel to the leading edge (see fig 4.1.12b). Does this measurement comply with Plan D (860 -890mm) (YES/NO)?

ITEM 10 RULE 3.4.7

Is leading edge of rudder parallel to extension of a line from transom within +/- 10mm? (YES/NO).

1. Placing the straightedge vertically along the transom as near the centerline as possible and resting on the top and bottom edges of the transom, verify and record if the leading rudder edge complies within the dimension. This requires a rather long straight edge (about 1.5m), and it helps to mark 10mm near the bottom of the straight edge as a reference.

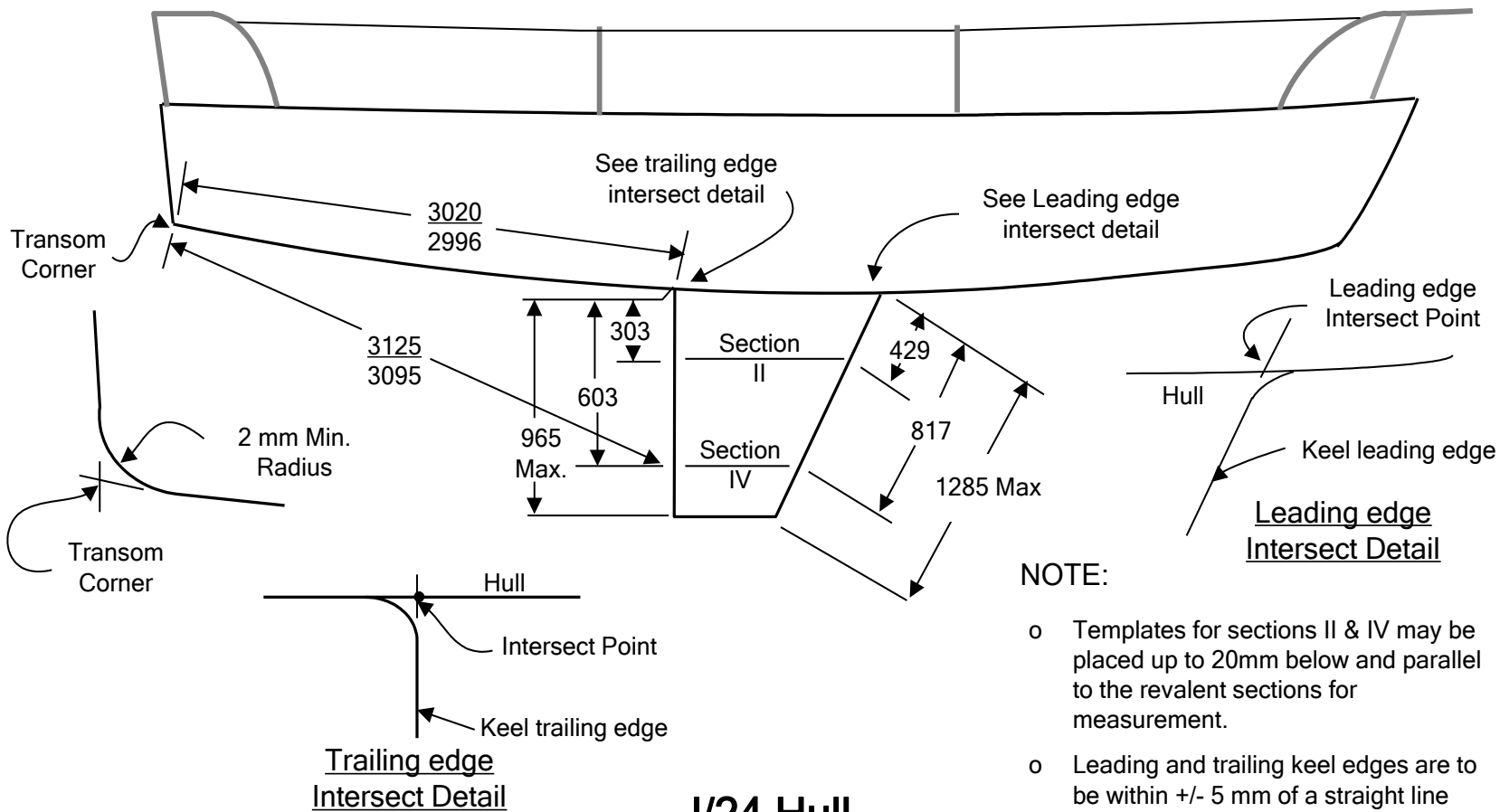

NOTE:

- o Templates for sections II & IV may be placed up to 20mm below and parallel to the revalent sections for measurement.
- o Leading and trailing keel edges are to be within +/- 5 mm of a straight line between sections I and VI.
- o It may be necessary to estimate the keel intersect with the leading/trailing edges if an intersect radius exists..

J/24 Hull Measurements

fig. 4.0

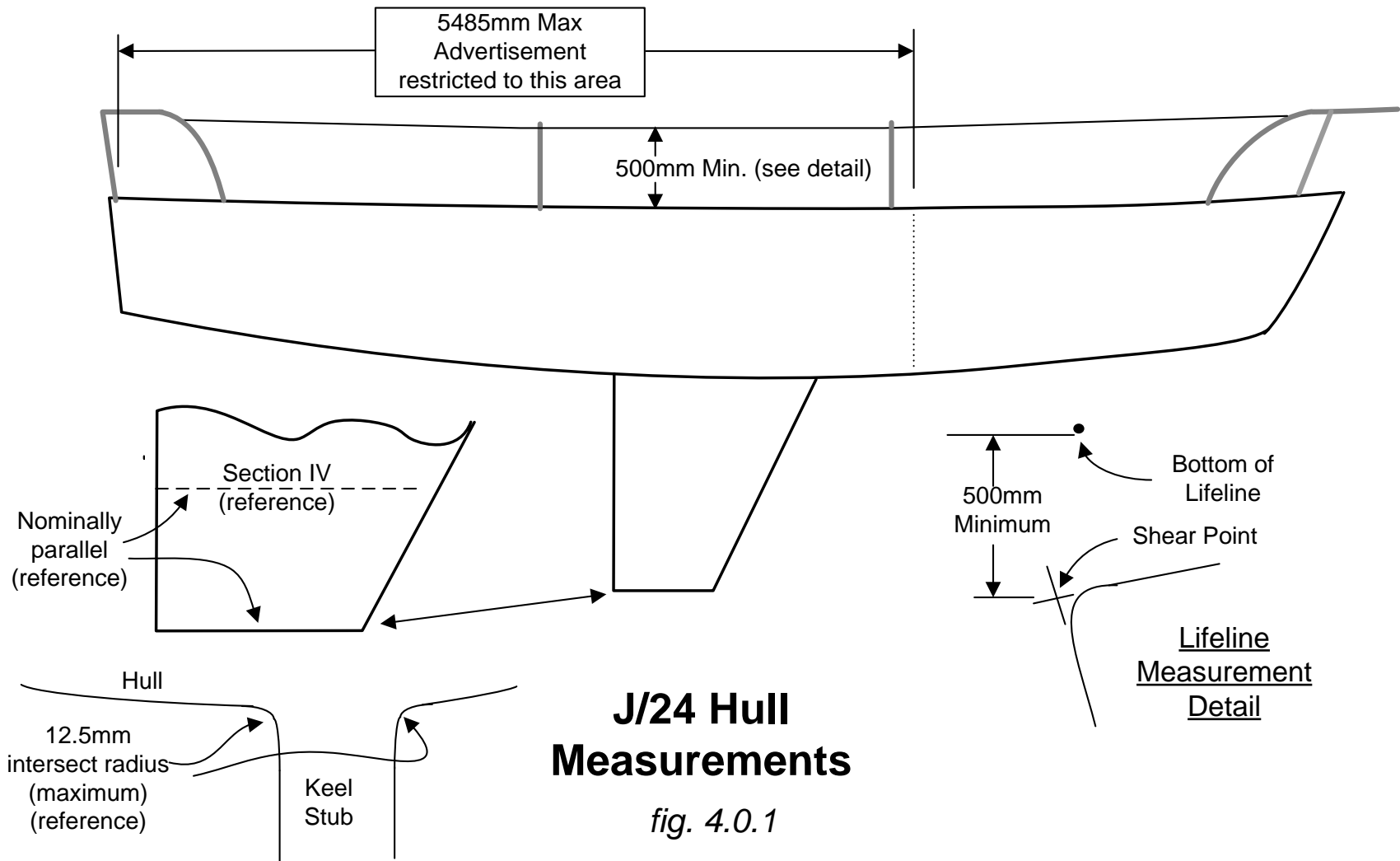

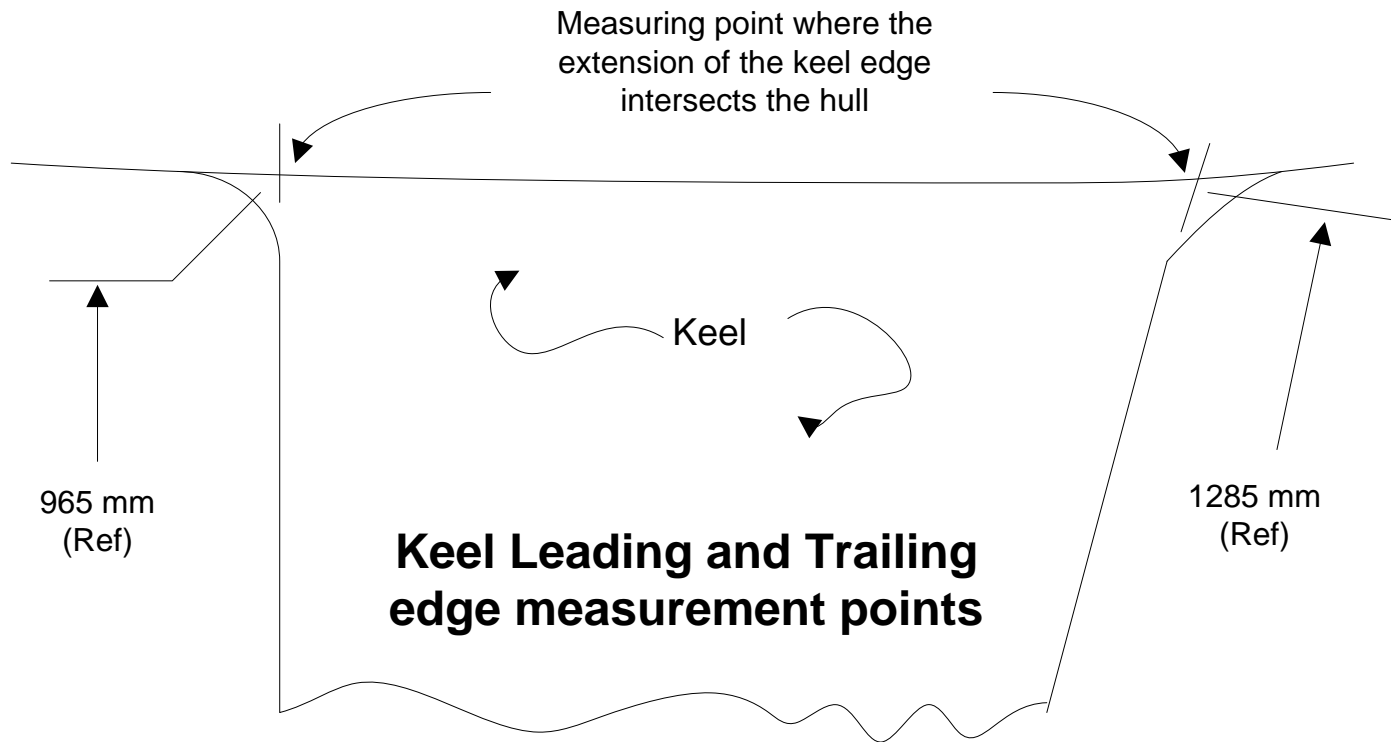
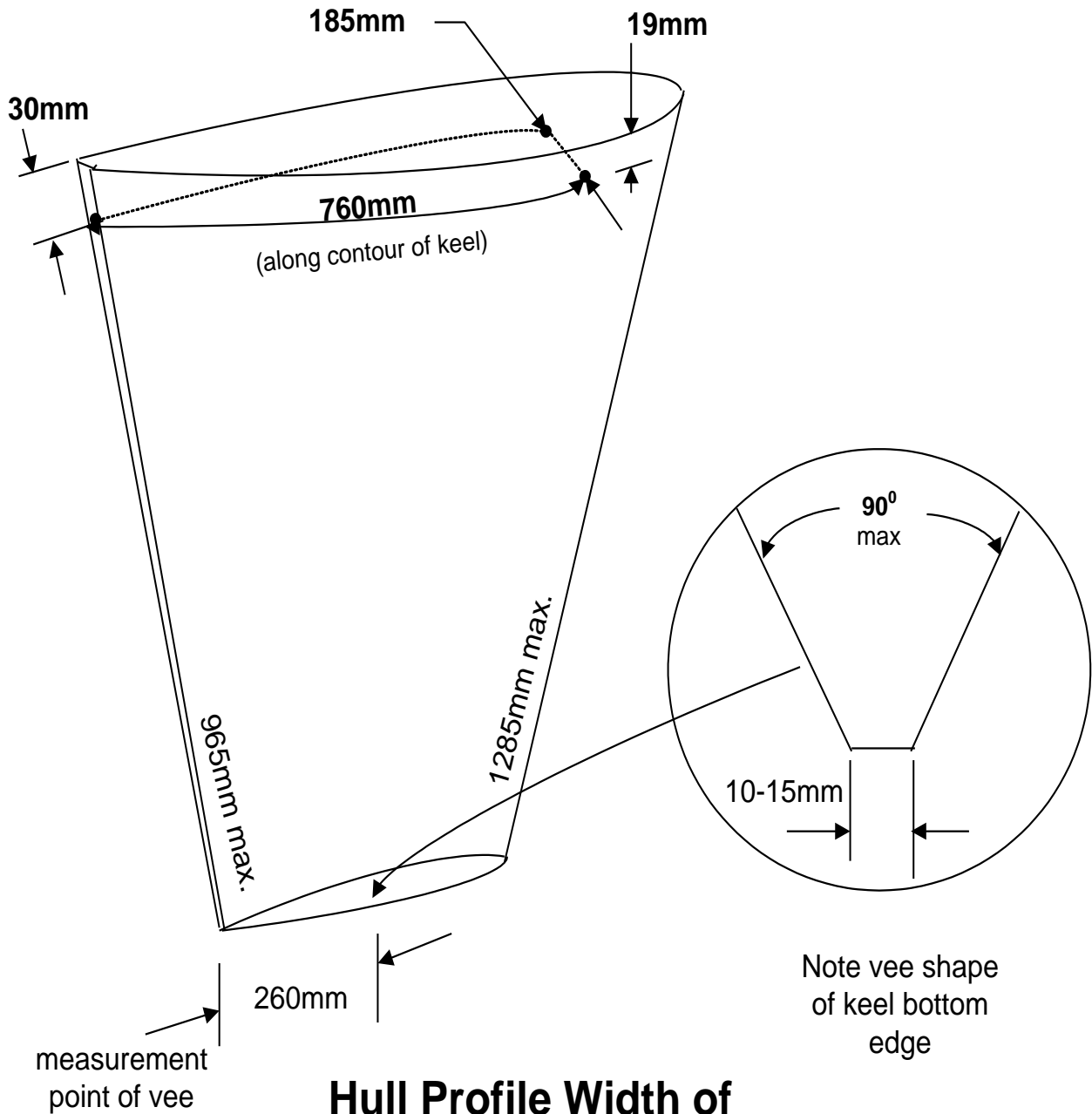
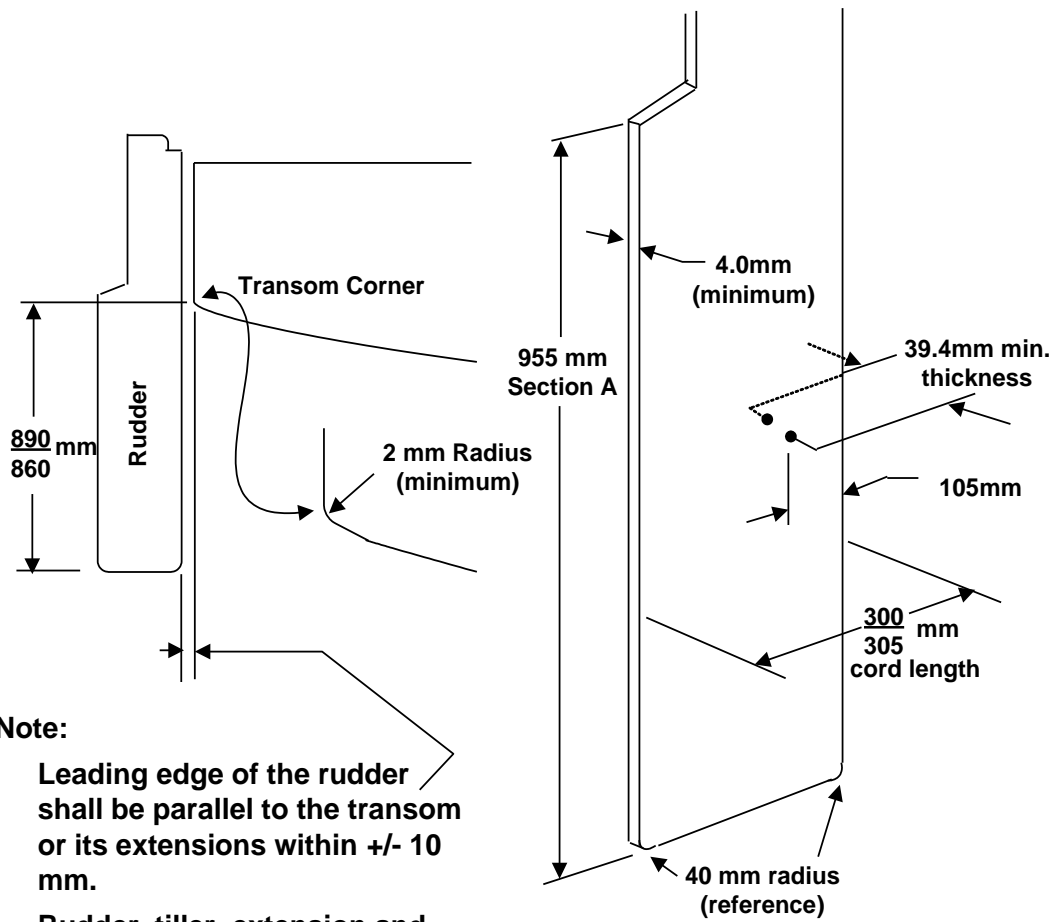

Fig 4.0.2



Hull Profile Width of Molded Keel Stub

fig. 4.1.11



Note:

Leading edge of the rudder shall be parallel to the transom or its extensions within +/- 10 mm.

Rudder, tiller, extension and fixed fittings shall be not less than 13.5 Kg. without throwl pins.

Rudder must comply with minimum faired dimensions of Plan D.

Fig. 4.1.12b

Rudder Measurements

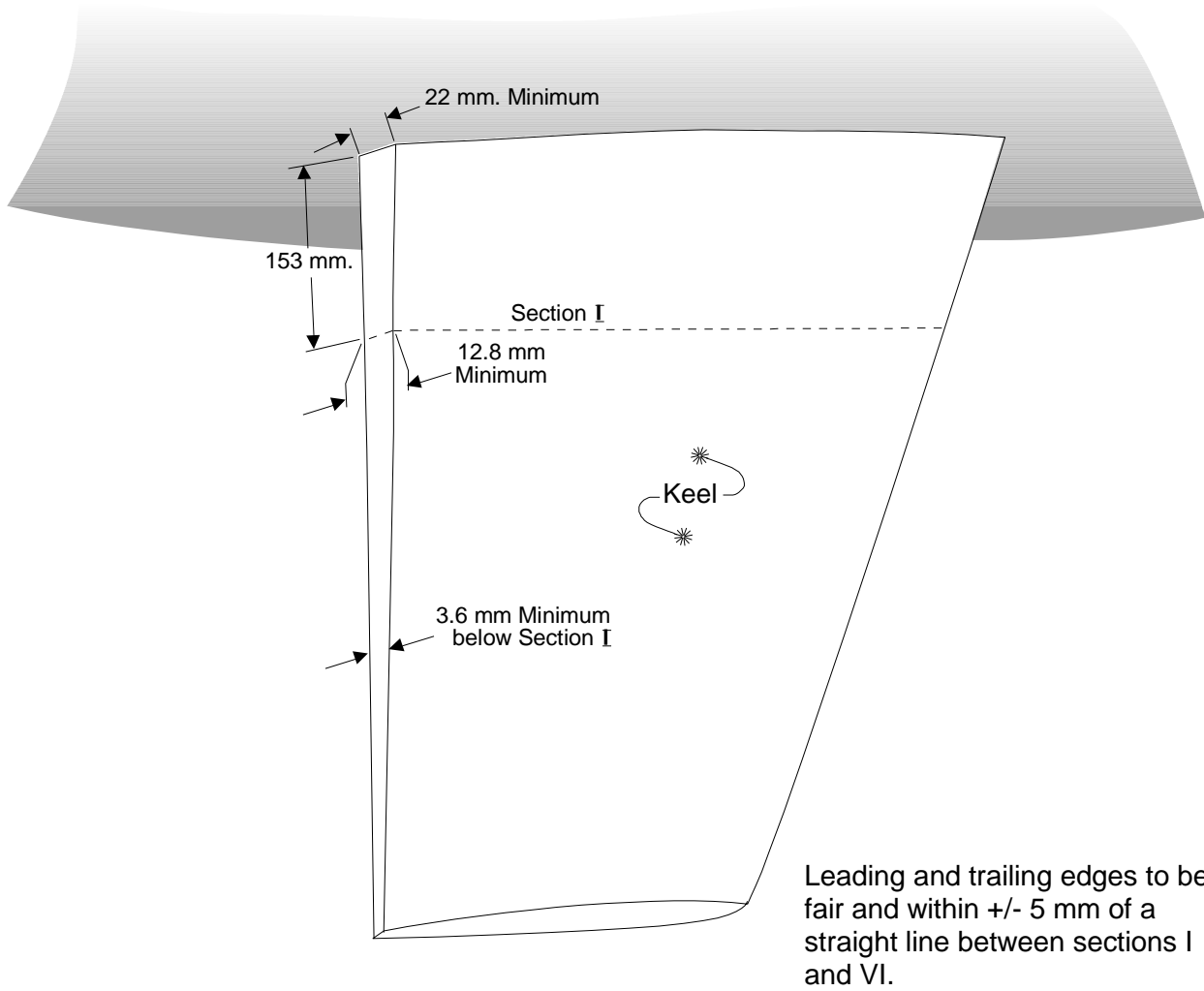

Fig. 4.2

Width of Keel at Trailing Edge

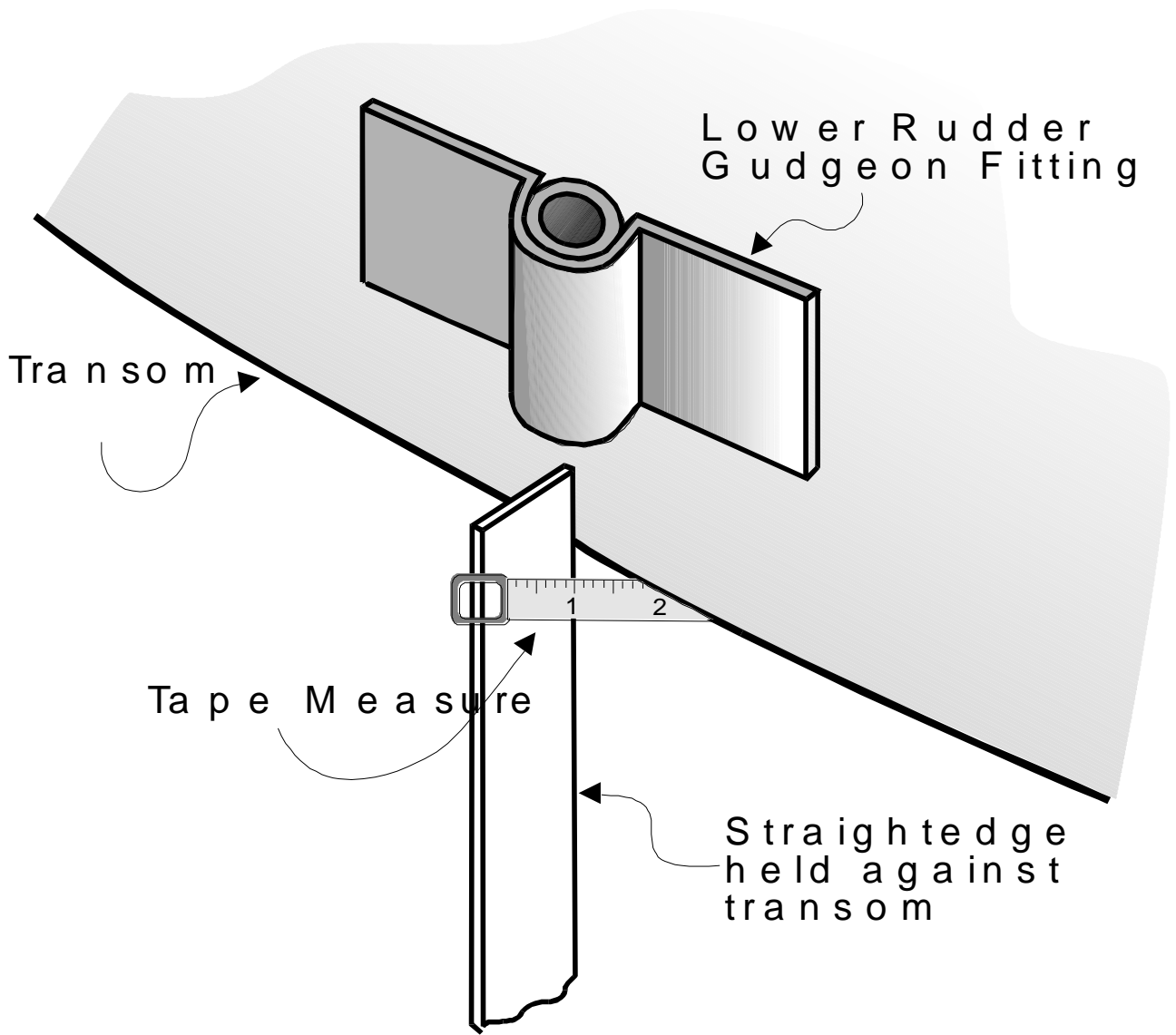
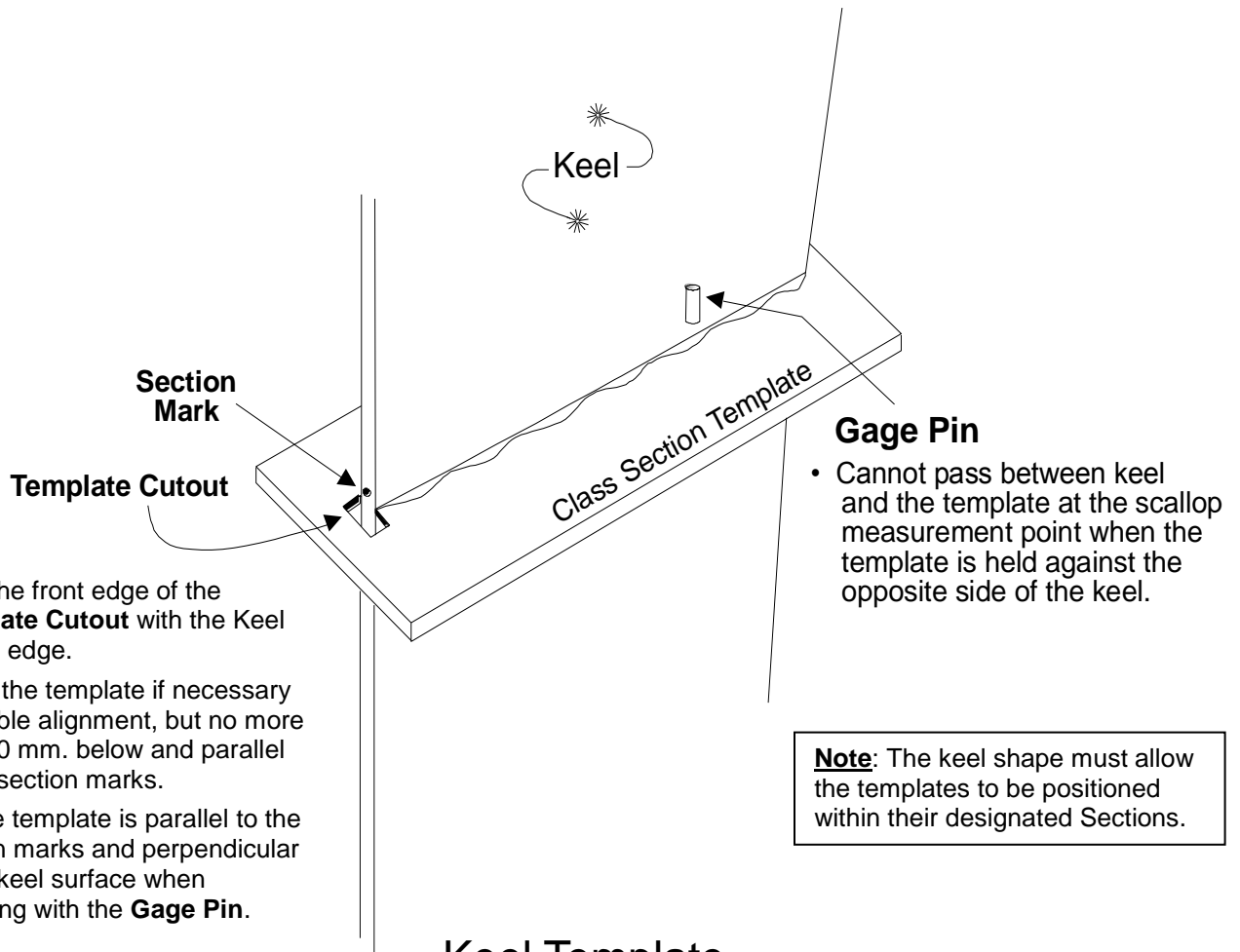

fig. 4.3.1b



Keel Template

fig. 4.6

5.0 Rig Measurement

This portion covers the spar, boom, spinnaker pole, spreaders and the sheer to mast measurements. All rule numbers and item numbers are underlined. Refer to fig. 5.0 as necessary.

To begin first have the mast section on saw horses or equal to allow all measurements to be made easily and to provide the owner a first hand look at the measuring procedure. **AVOID SENDING ANYONE UP THE MAST.**

5.1 Part D Measurements

ITEM #11 RULE 3.5.2e

Distance between forestay attachment and permanently marked lower edge of bottom band is 7725mm.

1. This measurement is taken from the center of the forestay attachment point down the forward face of the mast. Keep the measuring tape as straight as possible without obstructions.
2. At 7725mm make a permanent mark with a punch, knife, or chisel. Place a contrasting band of tape above this mark.

Measurer Reference Notes: measuring tape must pass through the spinnaker bales and all rigging must be moved out of the way to allow the tape to be as straight as possible. This mark is considered to be the **Mast Datum Point** as described in the **Equipment Rules of Sailing (ERS)**. **Take your time. Accuracy here is essential to several other measurements!**

ITEM #12 RULE 3.5.2d

Distance between mast bands.

1. Start by checking the location of the top of the lower black band at the gooseneck. The top of the band at the boom gooseneck is located at the height of the bottom of the boom sail track when the boom is at right angles to the mast (see fig. 5.0). It is helpful to use a device to aid in the transfer of the bottom of the boom sail track to the mast and to insure a right angle.!
2. Measure the distance from upper edge of the tape located at the standard boom height a distance of 8538mm toward the upper end of the spar. This is the distance between mast bands. Place the lower edge of a contrasting band of tape or paint at this mark.
3. Correct, if necessary, the location of either of these bands.

Measurer Reference Notes: You may allow a tolerance of +/- 2mm to compensate for the difference in coefficient of expansion between the steel measuring tape and the aluminum mast. It is helpful to use a stiff piece of paper or a piece of flexible plastic that has a straight edge to wrap around the mast to mark a line to follow with the tape to keep the tape mark perpendicular to the longitudinal axis of the spar.

ITEM #13 RULE 3.5.2f

The location of highest spinnaker boom attachment above lower edge of bottom band.

Measure from the bottom of the lower permanent mast mark (**Mast Datum Point**) to the center of the highest ring. This should measure 1555mm or less. (Y/N)

ITEM #14 RULE 3.5.3f

Standard installed fixed spreader length.

1. Measured from the end of the shroud bearing point down the center of the aluminum spreader to the mast surface. Min. 760mm, max. 800mm. Do not measure tip or mounting plate. Measure both spreaders. See fig. 5.0. Mark Y/N for compliance.
2. Note: If measured from the outer surface of the bracket, the bracket thickness must be added.

ITEM #15 RULE 3.5.3f - No longer in use

ITEM #16 RULE 3.5.6

Length of spinnaker pole including fittings.

1. Place one end of the spinnaker pole against a flat surface then measure from the surface to the end of the opposite fitting. See Fig. 5.1. This is a length from the ends of the end fittings. This should be 2895mm or less (Y/N).

ITEM #17 RULE 3.5.6

Weight of spinnaker pole including fittings.

1. Use a hand held scale of sufficient accuracy to weigh the pole in tenths of a Kg.. Includes all fittings and bridle. Min. 2.7kg. (Y/N) See fig. 5.1.

Measurer's note: Taped on weights are not acceptable to bring spinnaker poles up to weight. There should also be nothing rolling around inside the pole. The intention of the weight limitation is to make sure the poles are strong enough. Added weights do not add strength.

ITEM #18 RULE 3.5.3b

Height of forestay attachment above sheerline (I) abreast forward surface of mast.

1. This rule sets a minimum height of the sailplan above the hull (sheerline), as measured from the forestay attachment at the mast. It approximates what is commonly referred to as the "I" measurement. The effect of the rule is to disallow excessive mast rake accomplished by shortening the mast. The method of measurement, which uses the sheerline rather than the mast bearing beam as the lower measurement point, removes builder inconsistencies found in the height of the mast bearing beam. Thus, the overall length of the mast is irrelevant
2. This measurement is easiest to determine using the 400mm mast jig. Care must be taken that such jigs are measured frequently for accuracy, and that the jig is properly placed at the measurement points on each sheer. The distance down to the Mast Datum Point, 7725mm, added to the 400mm that the jig measures from the sheerline totals 8125mm, the minimum height of the forestay attachment point above the sheerline. As long as the Mast Datum Point is above the 400mm shown by the fixture, the measurement is within specifications. Mark the form Y/N. The difference below the Mast Datum Point (7725) and the line at 400mm above the sheer, is the amount that may be cut off to make the mast minimum height.

Measurer Reference Note: when setting up any 400mm mast jig, check that the shear points abreast the mast do not exhibit any unusual dip from a fair line along the edge of the deck and hull. This can be easily verified using a batten or similar flexible material and assuring that the shear is a smooth line.

ITEM #19 RULE 3.5.3c

Distance between fixing point of the forestay on mast and intersection of stemline and sheerline.

1. This distance is measured from the center of the forestay pin on the mast to the intersection of the stem and sheerlines. This can be done with the mast up, by using the following procedure, only after the Mast Datum Point has been marked in place
2. Have mast secured such that the forestay may be unpinned from the stemhead.
3. Unpin the forestay from the stemhead and swing the forestay aft to the mast
4. Tension the forestay along a clear path from the mast fixing point down to the 7725mm mark, and mark that location on the forestay with the lower edge of a piece of tape. Use caution that the forestay is lying fair along the forward edge of the mast.
5. Reconnect the forestay to the stemhead, taking care not to disturb the tape mark.
6. With no slack in the wire, measure the distance between the tape mark and the bow measurement point shown in fig. 5.0
7. If the measurement you get, when added to the 7725 from the Mast Datum Point to the forestay attachment is between 8595 and 8670mm the mast is in compliance. Mark Y/N.

ITEM #20 RULE 3.5.2b

Distance from Mast Datum Point to the stem at sheerline

This is commonly referred to as the “J” measurement. It is measured from the Mast Datum Point to the intersection of the stemline and the sheerline. Refer to Fig. 4.0 for the definition of the stemline/sheerline intersection. This measurement should fall between 2895mm and 2925mm. Y/N

ITEM #21 RULE 3.5.2c

Mast chocked to prevent movement at deck and fixed so as not to move on the mast bearing beam.

1. Visual only, YES or NO.
2. The mast may not "float" within the deck hole. Likewise, the mast butt plate must be fixed at the heel (mast bearing beam). Screws or pins must be used to secure the mast heel to the bearing beam. The chocking at the deck must not allow any movement and may be placed within the partners or may be a plate fixed directly on top of the partners.

Measurers Reference Note: This should be checked during an ‘on the water’ inspection. The deck chocks may not be adjusted after measurement at a regatta, and the mast heel may not be moved while racing.

ITEM #22 RULE 3.5.4 & RULES 6 & 7

Does running rigging comply with class rules?

Rule 3.5.4 describes required running rigging. Rule 6 describes Optional Equipment. Rule 7 describes Prohibitions. Does the rigging you see on the boat comply with all of these rules? Y/N

5.2 Table of Running Rigging Maximum Power Ratios

Rule	Application	Maximum Power Ratio
3.5.4(d)	Boom vang (kicking strap)	8:1
3.5.4(f) 3.5.4(g)	Mainsail outhaul Cunningham controls	6:1
3.5.4(h)	Backstay adjuster tackle	4:1
3.5.4(i)	Mainsail mainsheet	6:1
3.5.4(j)	Mainsheet traveler control lines	2:1

ITEM #23a RULE 3.5.5c

Distance of 20mm boom band from mast.

1. See also: Rule 3.5.5 in its entirety. This dimension should be no more than 2970mm. Y/N
2. The measurement is taken from the aft face of the mast to the forward edge of the band, while the boom is held amidships and perpendicular to the mast. Note that any deviation in the angle of the boom, either vertically or side-to-side, will vary the measured distance. A contrasting band of minimum width 20mm should encircle the boom. Refer to *Fig 5.0*.

ITEM #23b RULE 3.5.5c

Tip weight of boom measured at outhaul when horizontal on mast without mainsheet and vang fittings 3.3kg or greater? (Yes/No)

1. Ensure that everything to be weighed is dry and in its normal position, and that no tension is applied to any part of the outhaul which is not cleated on the boom. The mainsheet and vang, including related shackles and blocks, are removed from the boom prior to weighing. Permanent attachment (e.g. bolting) of weight to the boom at the outboard end may be required.
2. Attach hand scale of sufficient accuracy (measurement within 10ths of a kg) to the outhaul at boom end, scale should read not less than 3.3kg's. The approximate weight is the same as two "D" batteries, but if needed the weight must be permanently installed at the end where the mainsheet attaches.

Measurer's reference note: Any weights necessary to bring the tip weight up to minimum must be permanently installed. No taped on weights will be accepted.

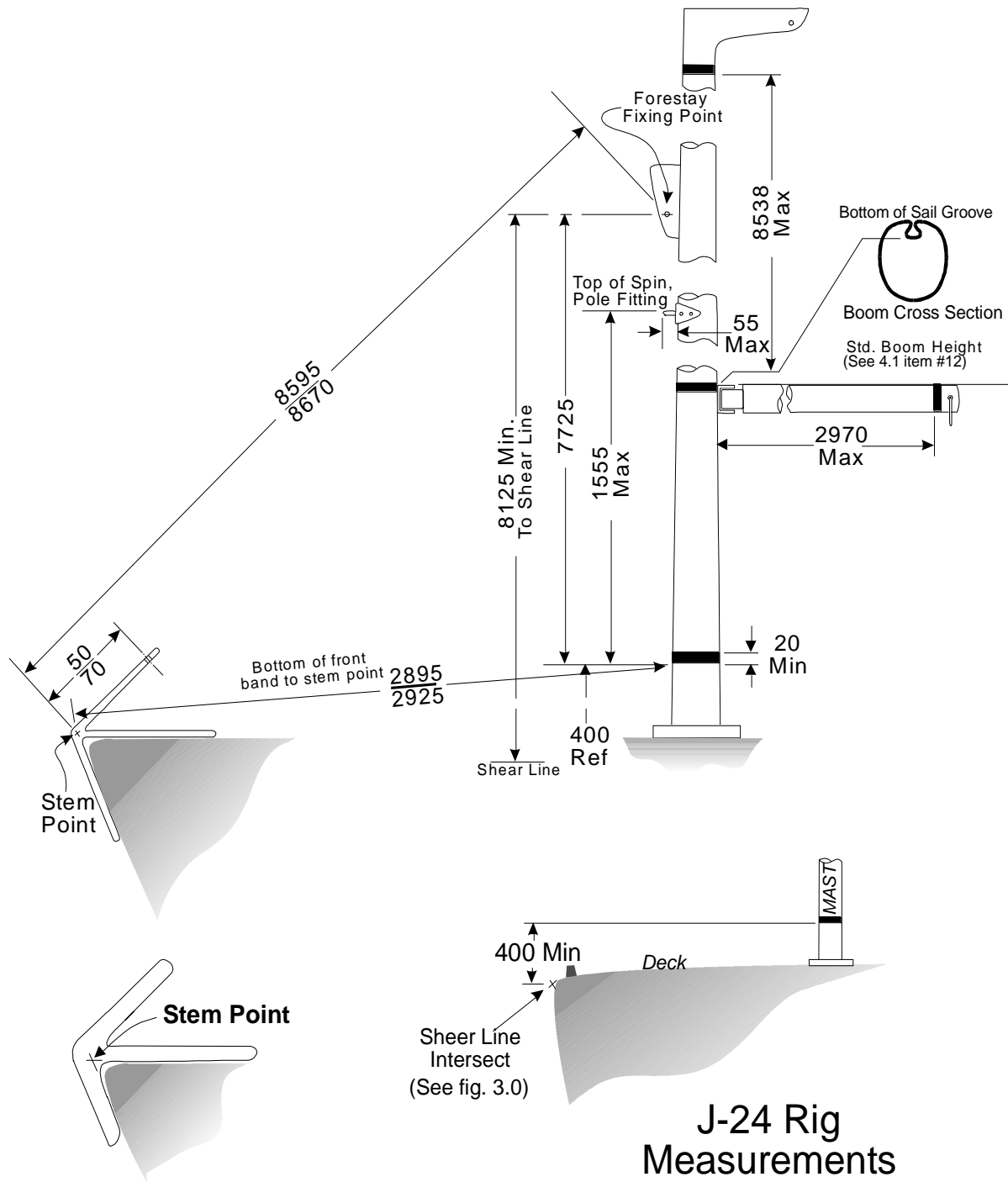

J-24 Rig Measurements

Fig 5.0

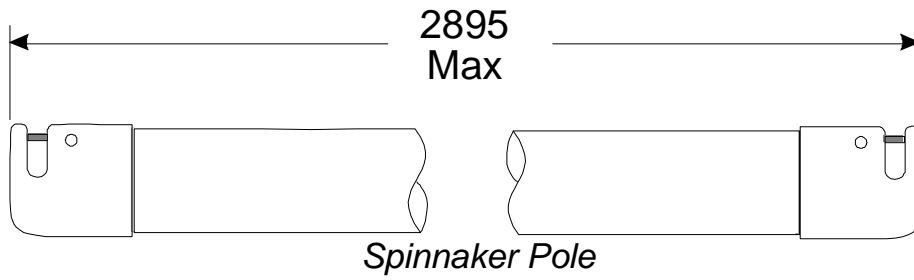

Note:

- Spinnaker pole and fittings shall not weigh less than 2.7 Kg.

Fig. 5.1

MEASUREMENTS TAKEN ON DECK AND PROCEDURES REGARDING DECK AND CABIN

6.0. Deck and Cabin Items

ITEM 24 RULE 3.2.5

Upper lifelines 500mm minimum above sheerline? (Yes/No)

1. Upper lifelines must be **taut** (no sag), of wire not less than **4mm** diameter, and not less than **500mm** vertically above the sheerline at all points along their length. Additional attachment points may be added to the pulpit and pushpit, but factory-installed attachment points may not be removed. The pulpit and pushpit heights shall not be altered. Measure the height at the midpoint between stanchions (refer to fig. 4.0.1).
2. Because the mid point of the lifelines between the stanchions is inboard of the hull sheer the height cannot be measured directly. Instead, the lifeline height at each stanchion is measured and verified to be in compliance. Then a thin line is stretched between the stanchions at the bottom of the lifeline and the gap between the lifeline and line measured. The amount is subtracted from the stanchion height and the resulting number is the lifeline height dimension.
3. Lifelines can be secured at either or both ends by a lanyard. A maximum gap of 100mm is allowed between the end of the lifeline fitting and the connection point on the pulpit or pushpit.

ITEM 25 RULE 3.2.5

Lifeline stanchions inboard of sheer in plan? (Yes/No)

1. Referring to the two intermediate stanchions on each side of the boat, no part of a stanchion may extend beyond the vertical extension of the sheer.

ITEM 26 RULE 3.2.4

Sink/drain/water tank or stove/fuel fitted? (Yes/No)

The cabin molding on the starboard side aft of the main bulkhead **may** be fitted with a basin, sink or stove. This is optional equipment. A basin is a permanently attached container to receive and hold smaller gear. A sink need not have a functioning drain (this used to be a requirement). Stoves are allowed but rarely seen. Please note in the comments section which, if any, of these items is permanently attached on board.

ITEM 27 RULES 3.1.4, 3.8, 8.1.2, 8.1.3

Fixed fittings and equipment located according to Class Rules? (Yes/No)

1. See also Rules 1.2, 1.3, 3.4, 3.5, 3.7.2, 6 & 7

2. Note: As a reminder to measurers, inspect the boat for sail track compliance with Plan 'A'. Also note that the mainsail traveler bar may extend to the outer edges **of the deck cutout** but no further.

ITEM 28 RULE 3.7.1

Dry weight without additional correctors

1. Boat weight dry prior to adding any corrector weights. Boat may already have corrector weights installed. If so confirm that they are properly installed and secured.

ITEM 29 RULE 3.7.2

Total weight of additional correctors

1. Enter the amount of the corrector weights required to bring the boat up to the minimum weight. If corrector weight's are already in place leave this value blank. Add a comment that the boat already has corrector weight's in place in the **COMMENTS** section.

ITEM 30 RULE 3.7.1

Basic Yacht Weight

1. Enter the sum total of ITEM 28 and ITEM 29. If corrector weights are already in place enter the value in ITEM 28.

7.0. Sail Measurement

Introduction

Sails are not part of the Measurement Certificate but are event requirements. Dimensions for sails can be found in Appendix A of the Class Rules. It is assumed the Measurer will be consulting the Class Rules for additional information not covered here.

7.1 Site and Layout

Guidelines for site selection and layout:

Selecting the site for a sail measurement is an important part of regatta preparation. Working with the Regatta Chairperson early in the planning stages can make sail measurement a comfortable process for both the competitor as well as the measurement team.

The site should be flat, clean, well lit, dry and out of the weather. The parquet floor of the yacht club ballroom is the site of choice, but a gymnasium, warehouse, dining room or sail loft are good sites as well. If you must measure on carpet it must be a low, level loop commercial grade material or the tape marks might move, over the duration of measurement. The criteria are: flat, clean, well lit, dry and out of the weather.

The layout of the measurement area is dependent to a certain degree on the way the sail measurement team is organized and the number of measurers available. The ideal organization would be one person to coordinate the sails to be measured and keep track of the paperwork and materials, and four teams of two persons, making one team for each class sail to be measured. If the measurers and space are available, a separate measurement area for each sail makes sail measurement very fast. If required, a smaller area can be utilized using a coordinator and two or three teams of two persons by laying out the jib and genoa diagrams atop one another and the mainsail and spinnaker likewise. Using different colored tape or pens to distinguish between the sails will reduce errors. Actual placement of the diagrams can be aided by using an older suit of sails and arranging them to fit the space available. Of course sails can be measured individually, but this is not recommended for regatta's when a considerable number of sails are to be measured.

Diagrams that follow fig. A.1.3.A show the areas needed for sail measurement only, they do not include the area needed for the waiting competitors and their sails. A "holding area" can be important at a large regatta.

Tape should be used (carefully on the parquet floor) to layout the various minimum and maximum dimensions as shown on the diagrams shown in Appendix A. You should indicate with an arrow the side of the tape to which the measurement is to be taken and provide a description of what is being measured. Refer to the diagrams in Appendix A, Section 1.6 for examples of tape markings. Using markers or pens that don't smear or wear off is, of course, advisable. It is recommended that materials are tested before beginning to avoid leaving stains or tape residue on the parquet or carpet. As mentioned earlier, color coding the tape or using different colored marking pens will facilitate the process when two sails are laid together.

The angles shown for the foot of the spinnaker are approximate and some shifting of the sails will be necessary. If it is possible to lay out our measurement area using a sail as guidelines for the angles, do so. If not, a protractor, an adjustable triangle or a hand bearing compass and a good eye work well.

7.2 General Information

7.2.1 PRINCIPLES OF SAIL MEASUREMENT

The basic principles of sail measurement are as follows:

1. The sail must be presented for measurement in a dry condition. Moisture in the material can affect the dimensions of a sail, especially the spinnaker.
2. The sail must be measured on a flat surface.
3. The tension applied to the sail must be just sufficient to remove wrinkles across the line of the measurement being taken.

Measurer Reference Note: *While this manual refers to laying out a floor pattern that is intended to allow a quick check of sail measurement conformance, it is a practice that is feasible only when many suits of sails are to be measured as taping down a floor area can take 1-2 hours. In cases where only a few sails are to be measured the use of a metal tape measure is more satisfactory. The sails will need to be laid out with enough tension to just remove wrinkles and measured using the dimensions indicated on the respective drawings (Figs 7.3.1 through 7.3.4). Upon finding that the sail meets the measurement criteria the measurer is to sign, including the date, across the royalty patch onto the sail cloth.*

7.2.2 REINFORCEMENT

Sails may have a primary reinforcement of any flexible material of coating, and secondary reinforcing of additional layers of cloth. Any reinforcement or finishing materials or coating shall not prevent the sail from being folded or damage the fibers when folded (refer to class rule 3.6.5 for details).

7.2.3 ADVERTISING MARKS

ISAF Measurement Instructions indicate that "Most sailmaker's like to display their name on their sails and IYRR 26 permits this to be done with certain limitations. These are:

- 1.) The sailmaker's mark shall fit within a square not exceeding 150mm X 150mm.
- 2.) The whole of the mark shall be so placed on the sail that it is not more than 15% of the length of the foot of the sail or 300mm from its tack, whichever is greater." Note: Marks shall appear on the starboard side of the Jib, Main, and Genoa sails.
- 3.) The location of the sailmaker's mark is shown on the sail diagrams.
- 4.) The sailmaker's mark may be placed on each side of the sail and that the second limitation above does not apply to spinnakers.

Measurers should note that some sailmaker's marks will fit within the 150mm square on the diagonal.

7.2.4 ROYALTY TAG LOCATION

1. Royalty tags are to be permanently attached to the Starboard side of the Genoa, Jib, and Main sails and near the Spinnaker clew.

7.2.5 SIGNING SAILS

1. When a measurer is satisfied that a sail complies with all rules, he/she is required to stamp, sign and date the sail per class rule 3.6.15. Note: the signature must cross from the royalty tag and onto the sail cloth.
2. The type of pen used to endorse sails is very important because the signature has to remain visible for several years. Ordinary ball point or felt tip pens are not adequate. Waterproof ink must be used. If in doubt, mark a rag with the pen you intend to use and launder in hot water to see whether the marking remains.

Measurers Reference Note: When inspecting sails that have been previously stamped, re-sign and/or stamp the sail to identify those sails selected for the regatta in question.

7.3.0 Procedures for Sail Measurement

7.3.1 MAIN SAIL MEASUREMENT PROCEDURE

1. Using the measurement points as shown on Fig. 7.3.1, measure leech, batten pocket locations, reef point, and headboard.
2. Fold Head Measurement Point to Tack Measurement Point as shown in Fig. A.2.b.
Mark sail at Half Height.
3. Fold Head Measurement Point to Half Height Mark as shown in Fig. A.2.b and mark the 3/4 Height. And fold Clew Measurement Point to Half Height Mark as shown in Fig. A.2.c and mark the 1/4 Height.
4. Unfold sail, measure the 1/4 Height Width as indicated in Fig. A2.a.
5. In similar fashion measure the 1/2 and 3/4 Height Widths as indicated in Fig A2.a
6. Note that width measurements shall be taken from a point on the leech, or from a point on a line bridging any hollows in the leech to the nearest point on the luff (i.e. perpendicular to the luff).
7. Referring to fig. 7.3.1, check the following:
 - A. Top batten length
 - B. Intermediate batten lengths
 - C. Lower batten length
 - D. Batten width
 - E. Window size and number
 - F. Batten pocket reinforcement
 - G **Class emblem conforms to class rule 3.6.7**
 - H. Sail numbers in accordance with 3.6.8
 - I. Sailmaker's label
 - J. Cloth weight marked and signed by the sailmaker on headboard per 3.6.9
 - K. Check that any advertisement is confined to the lower third of the sail (2800mm from the foot).
8. Check the minimum length of the foot boltrope at 2300mm.
9. Record Royalty number, stamp, sign and date sail.

7.3.2 JIB MEASUREMENT PROCEDURE

1. Measure the width of the head (at right angle to luff). Using the measurement points shown below, measure the luff length & reinforcement as indicated in Fig. 7.3.2.
2. Using the Clew Measurement Point indicated below, measure with tape the Diagonal (LP).
3. Referring to fig. 7.3.2, check the following:
 - A. Top batten length
 - B. Lower batten length
 - C. Window size
 - D. Hank width
 - E. Hank spacing
 - F. Sailmaker's label
 - G. Cloth weight marked and signed by the sailmaker on headboard per 3.6.9
 - H. Check leech to insure it is not convex.
4. Record Royalty number, stamp, sign, and date sail.

7.3.3 GENOA MEASUREMENT PROCEDURE

1. Measure the width of the head (at right angle to luff). Using the measurement points shown below, measure the luff length & reinforcement as indicated in Fig. 7.3.3.
2. Using the Clew Measurement Point indicated below, measure with a tape the Diagonal (LP).
3. Referring to fig. 7.3.3 check the following:
 - A. Window size
 - B. Hank width
 - C. Hank spacing
 - D. Sailmaker's label
 - E. **Sail numbers in accordance with 3.6.8 and located no higher than 50% of the luff.**
 - F. Cloth weight marked and signed by the sailmaker on headboard per 3.6.9
4. Record Royalty number, stamp, sign and date sail.

7.3.4 SPINNAKER MEASUREMENT PROCEDURE

1. Fold sail in half, leeches together, see Fig. 7.3.4.
2. Measure leech, stretch sail only enough to take wrinkles out of measured area.
3. Fold centerfold over to leeches, see Fig. 7.3.4, and measure centerfold.
4. Mark girth measurement points (2030mm & 4060mm) on centerfold and on leech.
5. Open sail to configuration shown in Fig. 7.3.4.
6. Measure, with tape, both midgirth dimensions and foot. See Fig. 7.3.4..
7. Referring to fig. 7.3.4 check the following:

- A. Sail numbers in compliance with 3.6.8
 - B. Sailmaker's label -
 - C. Cloth weight marked and signed by the sailmaker on headboard per 3.6.9
8. Check that any advertisement conforms to ISAF restrictions (at least clearly separated from national letters and sail numbers)
9. Record Royalty number, stamp, sign and date sail.

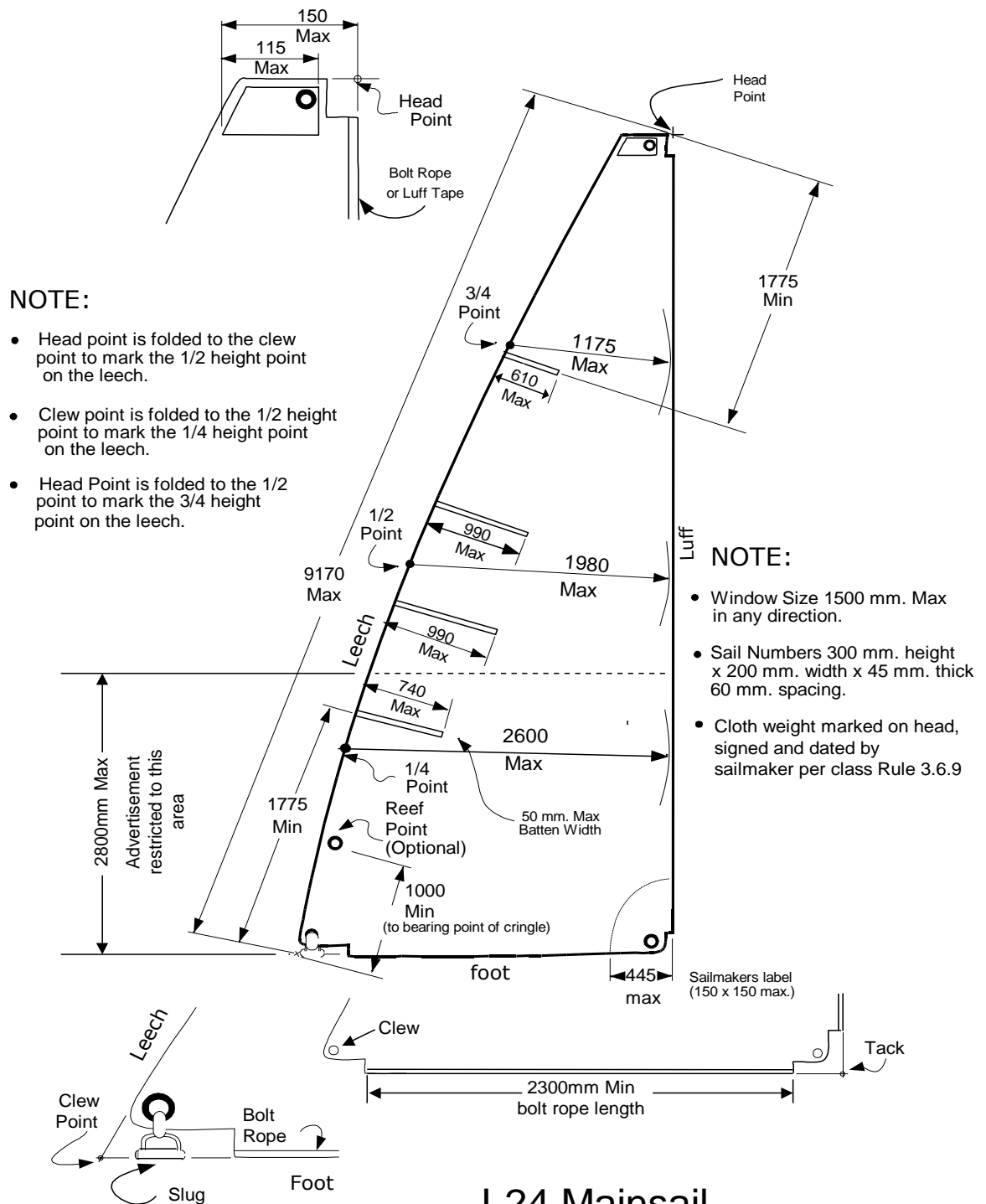

NOTE:

- Head point is folded to the clew point to mark the 1/2 height point on the leech.
- Clew point is folded to the 1/2 height point to mark the 1/4 height point on the leech.
- Head Point is folded to the 1/2 point to mark the 3/4 height point on the leech.

NOTE:

- Window Size 1500 mm. Max in any direction.
- Sail Numbers 300 mm. height x 200 mm. width x 45 mm. thick 60 mm. spacing.
- Cloth weight marked on head, signed and dated by sailmaker per class Rule 3.6.9

J-24 Mainsail Measurement

fig. 7.3.1

NOTE:

Window size 1500 mm max.
in any direction

Cloth weight marked on head,
signed and dated by sailmaker
per class rule 3.6.9

Sail numbers - 300 mm high x 200 mm
wide x 45 mm, 60 mm spacing

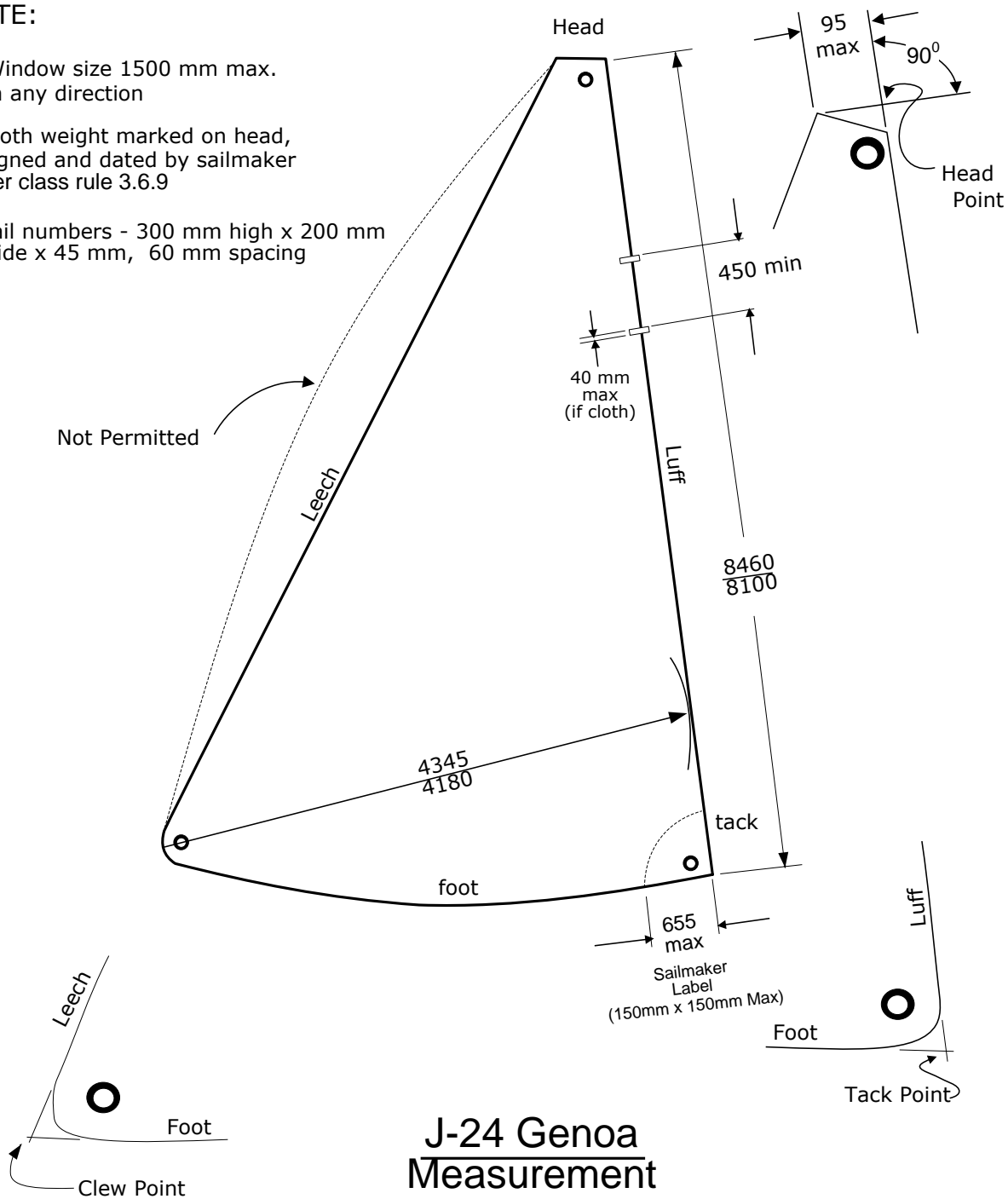

J-24 Gena Measurement

fig. 7.3.3

NOTE:

Window size 1500 mm max.
in any direction

Cloth weight marked on head,
signed and dated by sailmaker
per class rule 3.6.9

Sailmaker label 150 mm x 150 mm max

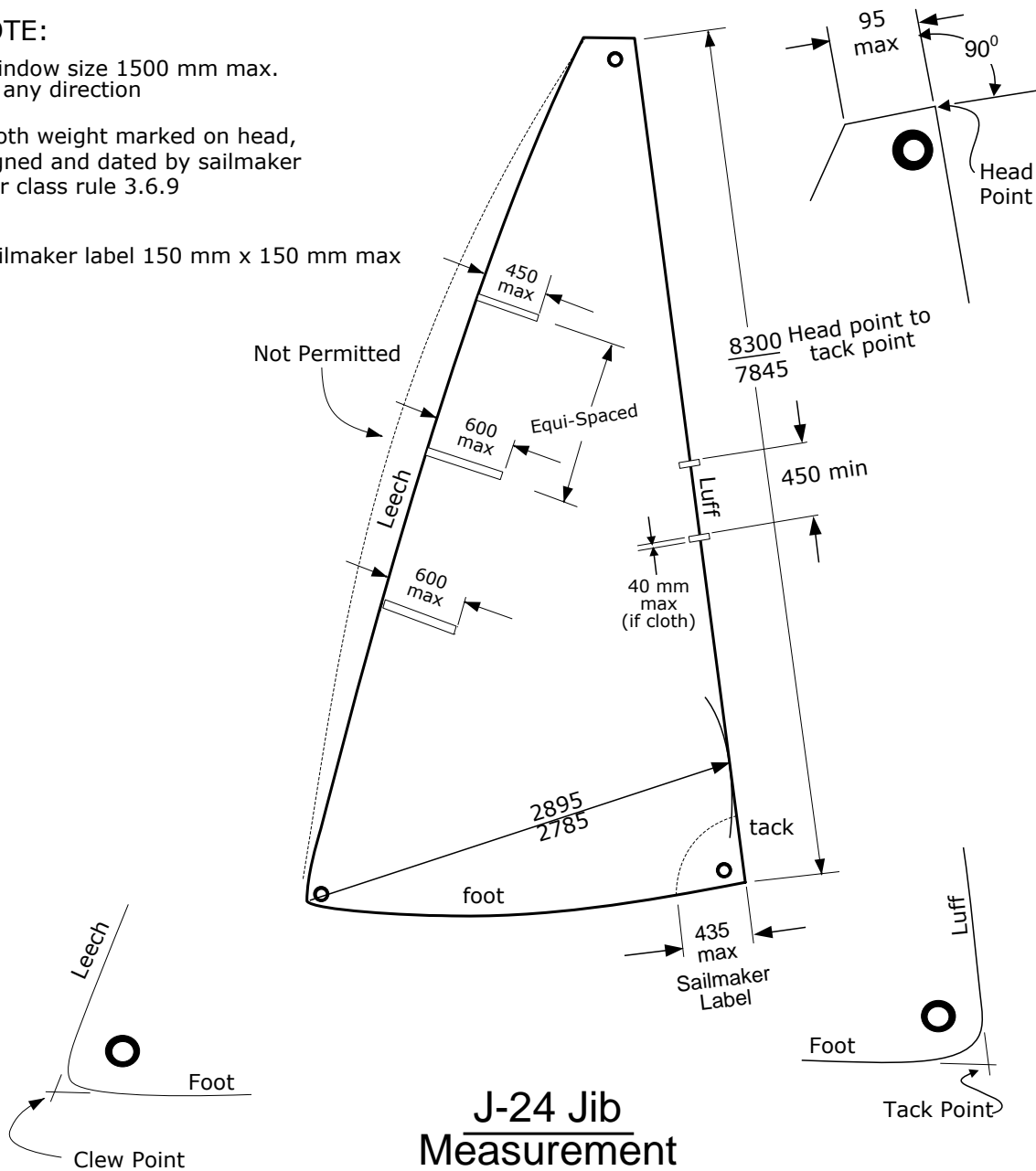

**J-24 Jib
Measurement**

fig. 7.3.2

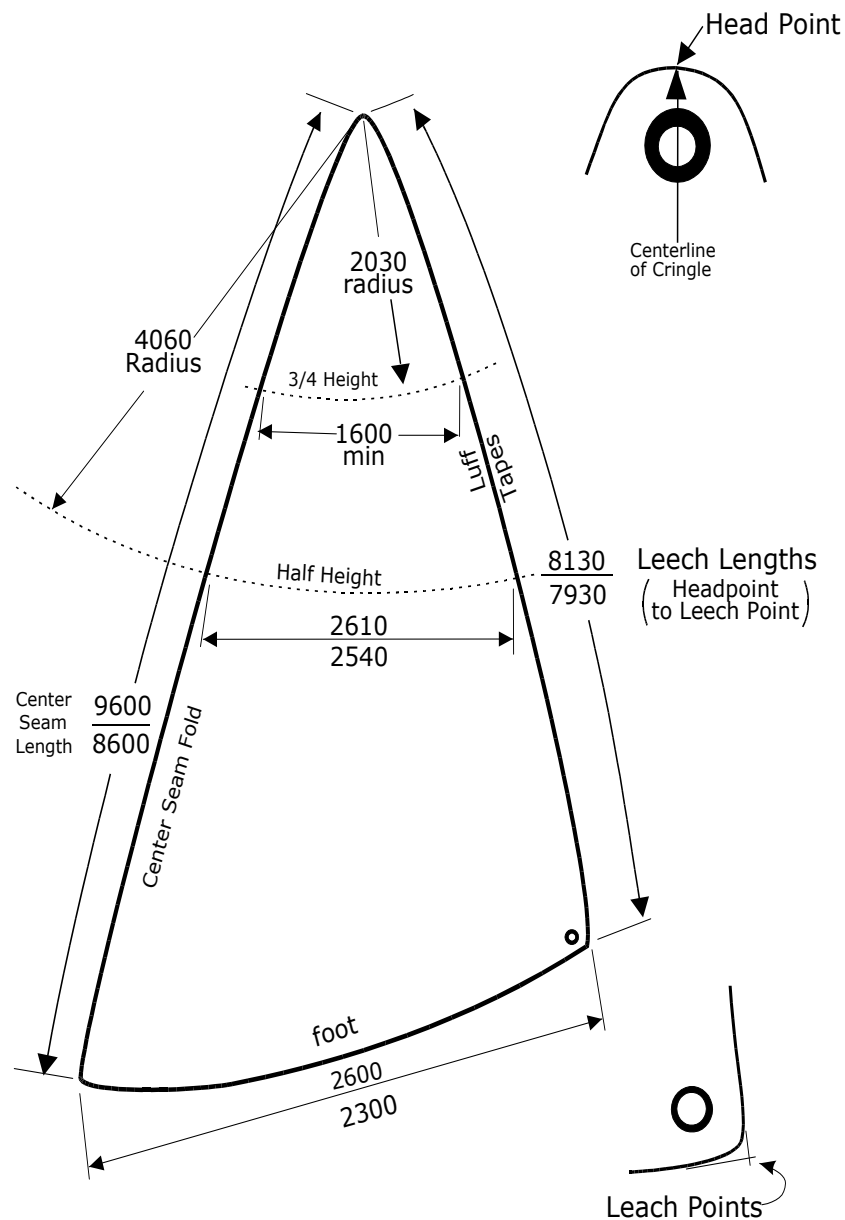

Note:

Sail Numbers 300 mm height
 x 200 mm width (except "1" and "I")
 x 45 mm thick - 60 mm spacing

Cloth weight marked on head,
 signed and dated by sailmaker per
 class Rule 3.6.9

J-24 Spinnaker
Measurement

(Sail folded vertically about center seam.)

Fig 7.3.4

8.0. Weighing

8.0 Introduction: The most frequent measurement requirement after sails is boat and crew weight. With the population of older hulls with their frequent repair and re-building modifications, it is necessary to assure that the boats are in compliance with class weight requirements.

8.1 Preparation of boat weighing Equipment

- 8.1.1 **Equipment:** Requirements for weighing boats include the availability of a class certified scale capable of weighing the 'yacht weighed dry'. It is required that the scale be re-certified prior to its use for National or World's class regattas.
- 8.1.2 **Weighing Conditions:** It is important that the boat weighing process be carried out in calm wind conditions. If possible choose a location that is sheltered from weather conditions to avoid erratic weight readings. Note: boat must be weighed dry, therefore, weighing in the rain is not permitted
- 8.1.3 **Caution:** Before using the scale, ensure that the batteries are fully charged. This usually requires several hours. Failure to properly charge the scale batteries can result in erroneous weight readings, hence incorrect weight measurement.
- 8.1.4 **Warning:** It is recommended that the battery charging system be checked for having an output voltage that matches that of the scale batteries. It has been the occasional practice to incorrectly replace a damaged charger with an incorrect voltage unit. This has resulted in early charger failure, hence, lack of proper charging of the scale batteries.

8.2 Boat Preparation

- 8.2.1 **Equipment required to be weighed:**
 - 8.2.1.a The boat as specified for the builders weight (rule 2.8.2)
 - 8.2.1.b With all spars, standing, and running rigging as defined in rule 3.5.
 - 8.2.1.c With installed outboard motor bracket and permanently fixed compasses (rules 3.8.10 and 4.1.3).
 - 8.2.1.d With all other permanently installed optional equipment permitted under rule 6.
- 8.2.2 **Boat Readiness:** Thoroughly inspect the entire hull interior to assure all items not included in the 'Boat Weighed Dry' listing are removed. Check the cockpit lockers (if in place) and interior storage areas for water or loose equipment. Lay all required but loose lines on the hatch to assure the inventory is correct.
- 8.2.3 **Corrector weights:** Inspect the boat for corrector installed in accordance with 3.7.2. Record the weights on the weight form (if available, an earlier measurement certificate may indicate the weight).
- 8.2.3 **Weighing conditions:** It is necessary for the boat to be weighed dry. It is recommended that the boat be out of the water for a period necessary to assure the hull is dry before weighing. Pre-weigh any lifting equipment such as bridles, guy lines, etc. This is usually accomplished by hanging the lifting equipment on the scale hook and 'zeroing' the scale. If not done, the lifting equipment must be weighed separately and the weight deducted from the indicated boat weight.

8.3 Boat Weighing Process

- 8.3.1 Remember to first turn on the scale before hoisting a boat to avoid the risk of climbing on a suspended boat to turn it on afterward. Also adjust the face of the scale so that the readout can be

seen after hoisting. A temporary shield (cardstock taped to the top of the scale) may be helpful in reading the output scale in bright sunlight.

- 8.3.2 In calm conditions, hoist the prepared boat clear of its trailer or cradle. Boats that have been in the water should be hung until dry before recording an official weight. Assure that those helping to steady the hull are not influencing the weight reading.
- 8.3.3 Record the indicated weight on the form (line 30 if correctors are in place, line 28 otherwise). Advise the owner / representative if the boat requires corrector weights, and their amount. If a boat needs correctors, note the fact as a comment on the measurement form. It will be incumbent upon the owner to add and properly seal any correctors.
- 8.3.4 Itemize unusual equipment permanently installed that is included in the weight (such as electronics, compasses, presence or absence of cabin top winches, etc.)

8.4 Crew Weighing process

- 8.4.1 For those regatta's requiring crew weight validation, contact the regatta host to assure a suitable scale is available. Ideally, a balance scale similar to those found in medical offices should be used, however, any suitable accurate scale is sufficient.
- 8.4.2 Use a crew weight form to record the individual weights (minimally dressed in swim wear clothing). Refer to Class Rule 5.1 for details. Note that Class rules require that the crew weight applies prior to the start of a regatta.

Appendix A. Sail Measurement Floor Layout

A.1 Introduction

Measurement of new sails to verify rule compliance is a daunting task that is required at every major class regatta. Using a tape measure for the process is very time consuming if more than a few suits are to be measured. A quicker method is the use of a floor layout with tape markings identifying the dimensions for each sail.

The layouts contained in this appendix are intended as a quick check of the measurement specification. If, during the measurement of a sail, it appears that the sail does not comply with a given specification it may be necessary to measure that feature with a metal tape.

The information contained in this appendix only refers to sail layout tape locations and does not include all additional measurements found in Section 6 of the manual. It is therefore necessary to follow the manual procedure to assure all sail measurement requirements are met.

A.1.2 Site Selection

Choosing a sail measurement site carefully is paramount to facilitating the organizing of the process. A finished wood surface is preferred, but any surface that can be kept clean is suitable. If a large number of sails are to be measured, measurer fatigue is greatly reduced by having the layout surface at approximately waste level. The site should be chosen to be away from the main regatta traffic areas to avoid congestion of the area and the risk of soiling the layout surface.

A.1.3 Getting started

Using an old suit of sails, arrange the Main, Genoa, and Spinnaker so as to allow approximately 1200mm (4ft.) of borders as walkways. Usually it is convenient to have the Jib layout overlaying the Genoa, and the accompanying figures show that overlay.

Figure A.1.3.a shows an example of one floor layout.

A.1.4 Materials and Equipment

- Metal metric measuring tape (50m. min. length).
- 50mm (2in) masking tape. Narrower tape can be used but may require more piecing to enable radial arcs to be drawn.
- Permanent marking pens of at least three (3) different colors. This will allow separate identification of each sail layout.

A.1.5 Personnel Requirements

Laying out the site requires at least two persons, of which one must be a class measurer.

During the sail measuring process at least one boat representative should be on hand to aid the process and stow completed sails

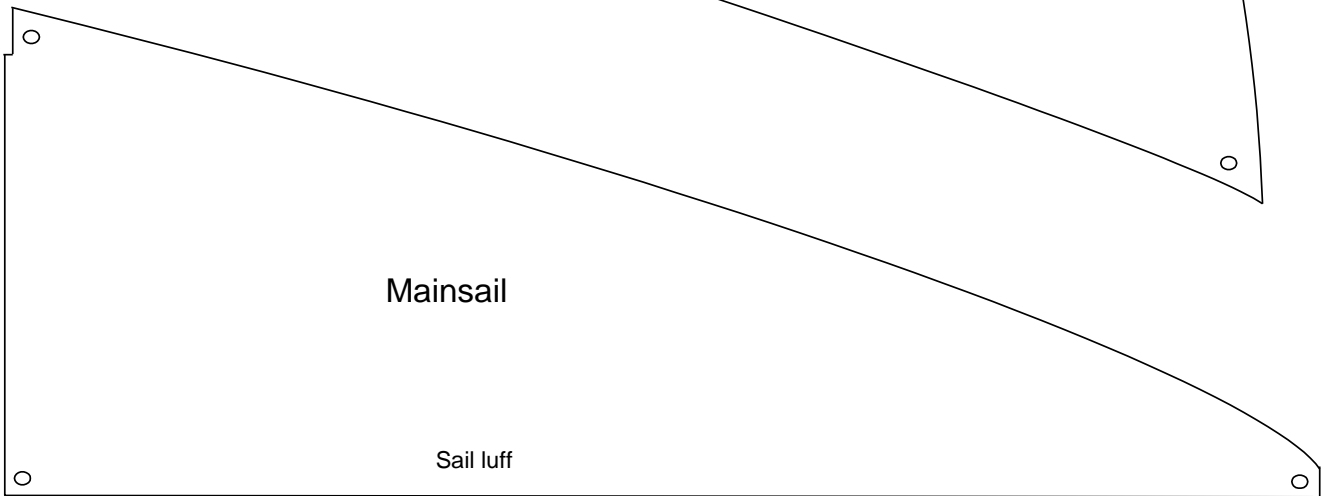
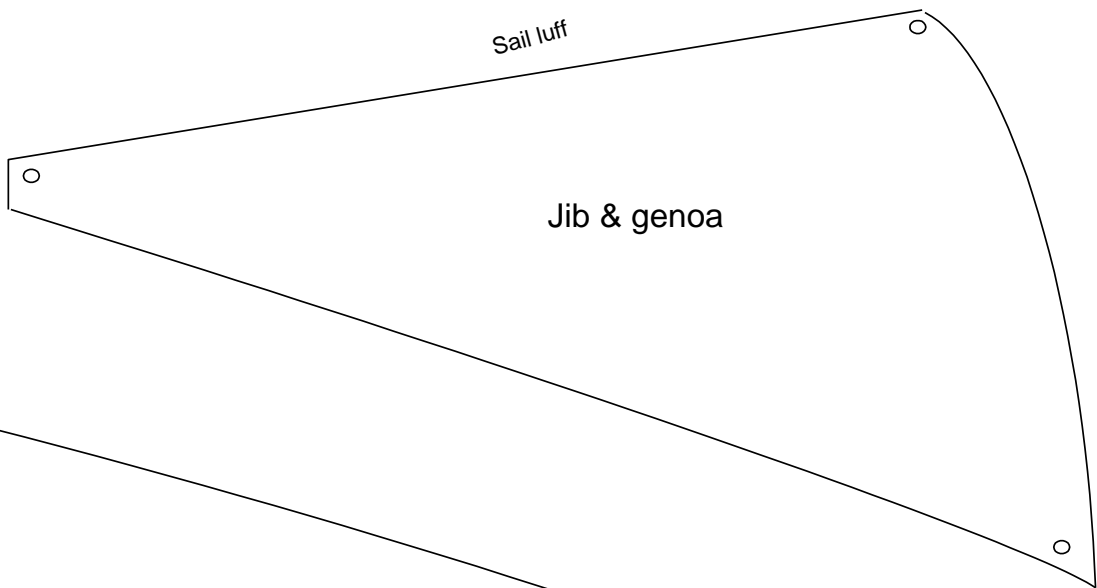
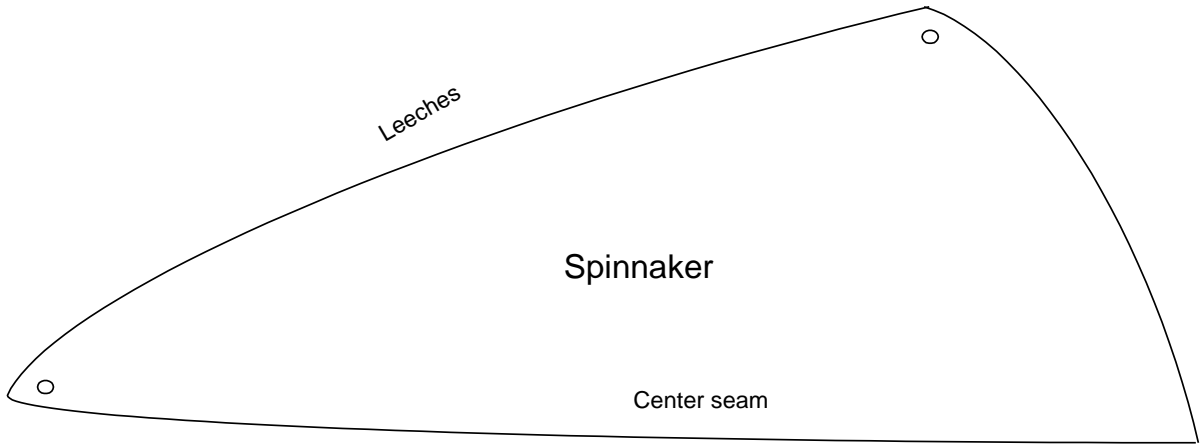

J/24 Sails

fig. A.1.3.A

sample floor layout

Keeping accurate records is a critical requirement of the measurement process. The task is frequently left to the measurers themselves. Recording errors can be avoided by the use of a dedicated individual. This is a good opportunity for a potential class measurer to gain knowledge of the sail measurement process.

A.1.6 Masking tape identification marks

The following conventions were used to identify the various sail measurement points:

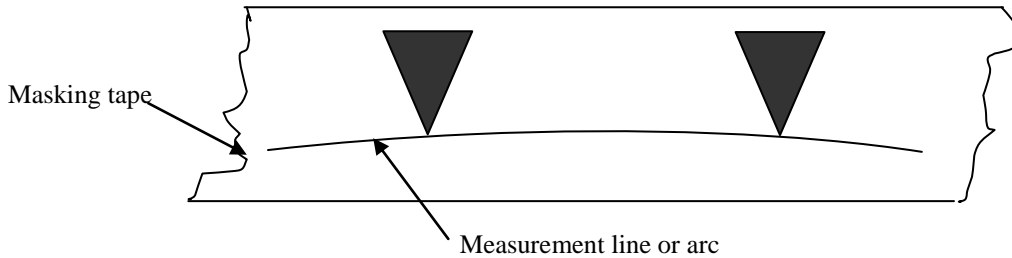

Identification of sail **Measurement Marks** – triangles identify which side of the line to measure to or hold a sail feature. It is recommended the purpose of the dimension is identified on the tape (such as: ‘Genoa Max. LP 4345mm’).

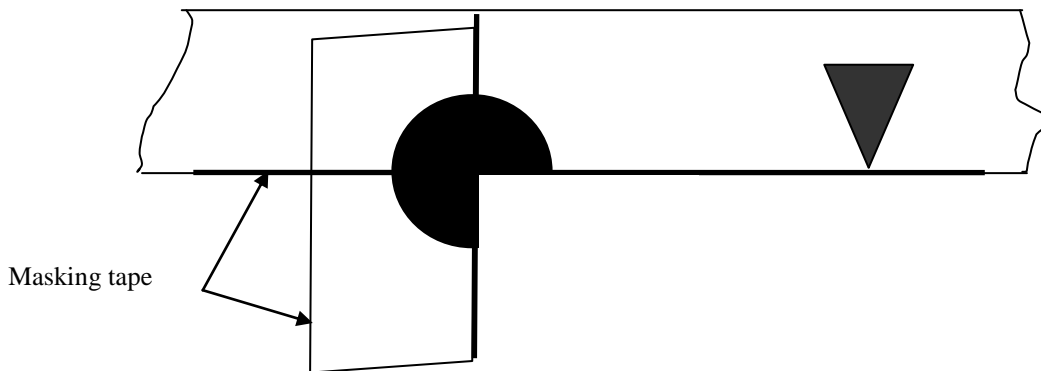

Identification of sail **Locating Point** – such as: ‘Mainsail Head Point’. Datum point can be semi circular as used in the spinnaker mid height locators.

Note that the layout markings will generally not be precisely located due to the nature of tape placements. Therefore, if a sail is found to not conform to the layout dimension it must be verified using a metal measuring tape. As most sailmakers know that the sails measurement is frequently a regatta requirement, most sails will conform to the dimensions so the usage of a metal tape is rare.

A.2 Mainsail layout (figure A.2.a)

A.2.1 Head Point:

Referring to figure A.2.a, place two pieces of approximately 200mm (8in) long tape at the head of the layout sail. Identify this as the Head Point. Note the additional markings for the head width (150mm) and the maximum plate width (115mm).

A.2.2 Leech Length:

Using the layout sail, place a piece of approximately 350mm long tape along the trailing edge of the sail at the Clew. Starting from the Head Point measure 9170mm in a straight line to the front edge of the Clew tape and mark the point. Place another length of tape parallel to the foot of the sail crossing at the mark. Add the necessary identification marks to identify this point as the Clew Point of the sail.

A.2.3 Girth Measurements:

Fold the layout sail following the diagram in figure A.2.b for the half height marking by placing the Head Point at the Clew Point. Place a small tick mark on the inside leech fold using a marker pen. Place a 75-100mm piece of tape at the leech fold and draw a locating point to indicate the position of the half (1/2) height sail mark. Measure along a line perpendicular to the sail luff a distance of 1980mm and place short pieces of tape to enable drawing an arc approximately 250mm long centered about that line.

Using the same process, refer to figure A.2.c and fold the layout sail Clew Point to the half height point mark and place the quarter (1/4) height mark at the fold. After adding a locator mark as above, place an arc at 2600mm radius from the locator.

For the three quarter (3/4) height fold the upper part of the sail to align the Head Point with the half height mark and mark the inside of the leech fold. Again, on a line approximately right angles to the sail luff, place an arc at 1175mm.

Remember to identify the locator points and their respective arcs as to the dimension they represent.

A.2.4 Batten Measurements:

At a convenient location, refer to figure A.2.a and place the Batten Length tapes following the diagram. These marks should be placed as accurately as possible to avoid the need of having to use a metal measuring tape to confirm the error if a batten exceeds its length restrictions (as is often the case).

Batten pocket locations: using the Head Point and Clew Point locating tapes (figure A.2.a), place a strip of tape at right angles to the leech and mark a centerline at 1775mm from each Point. The top and bottom batten pocket centerline must meet or exceed these marks.

A.2.4. Using the floor layout:

Remove the battens and place the main to be measured starboard side up over the marked area. Verify the head board dimensions (150mm from the luff & 115mm overall board width). Have an assistant stand on the cringle and gently stretch the sail leech to verify the 9170mm leech length restriction. Note that as most sails are well within this dimension, the sail clew will be the intersection of a continuation of the leech edge with the continuation of the foot (including any sail slug). This will require an estimate of the clew as the intersect point will fall outside of the actual sail material.

Check that the length of the foot rope is at least 2300mm.

To locate the sail 1/2 height mark, fold the sail so that the head point coincides with the clew point (see fig. A.2.b). Using a waterproof marker, place a small mark on the inside surface of the leech at the fold point. Open

the sail and fold the head point to that mark and in similar fashion, mark the $\frac{3}{4}$ height point. Lastly, fold the clew point to the $\frac{1}{2}$ height mark and as above, mark the leech for the $\frac{1}{4}$ height point.

Open the sail and position the $\frac{3}{4}$ height mark (top) on the respective leech target mark. Rotate the sail if necessary, to verify that some part of the luff falls within the 1175mm radius. In the same fashion, verify that the $\frac{1}{2}$ height and $\frac{1}{4}$ height girths are in compliance.

Using the batten length marks, verify their compliance, and after ascertaining the balance of the sail requirements (such as class mark, numbers, batten pocket location, etc. have been met, sign & date across the royalty patch. Note that if any part of the sail does not comply, **DO NOT SIGN THE SAIL UNTIL IT HAS BEEN CORRECTED!**

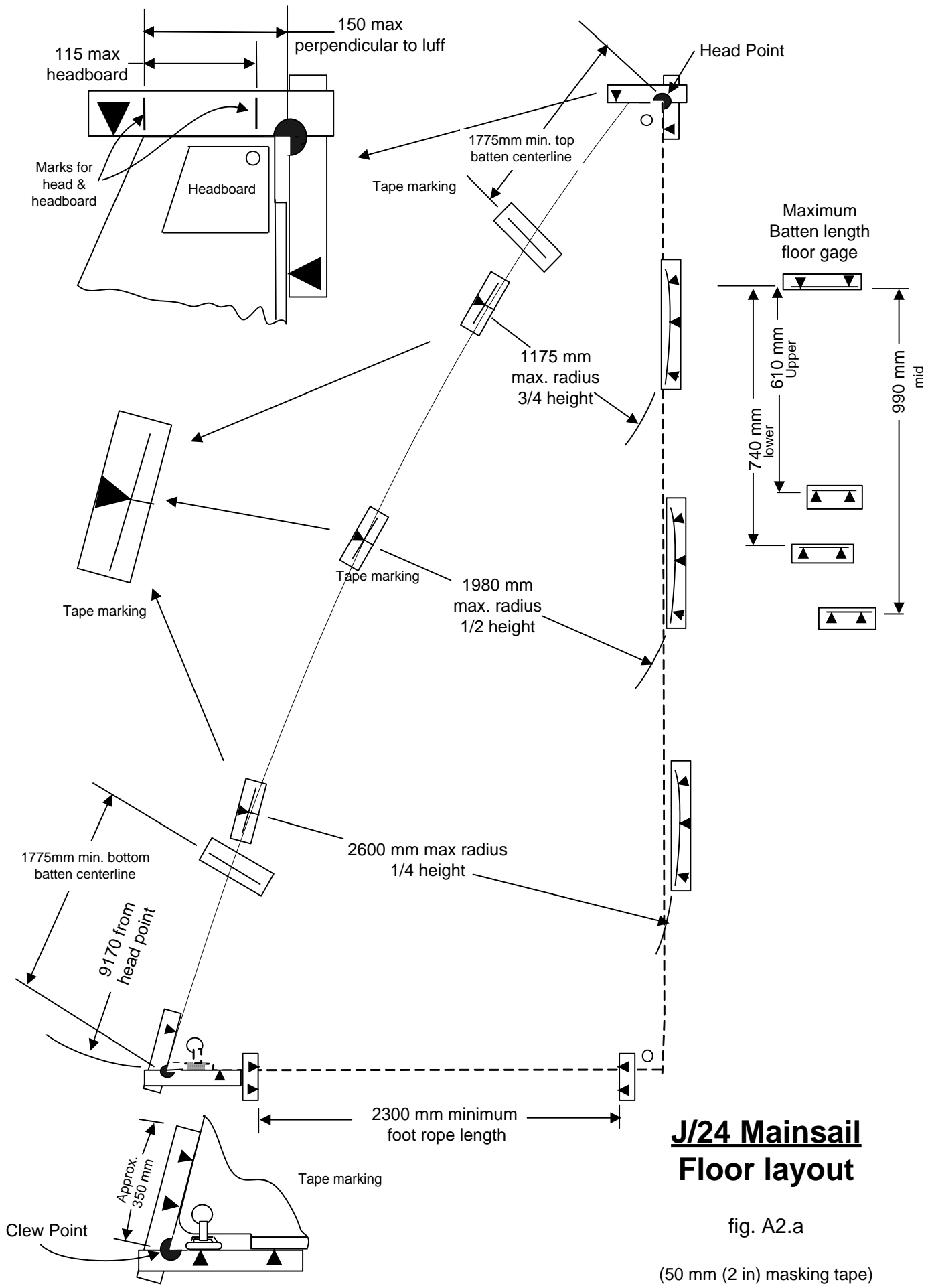

**J/24 Mainsail
Floor layout**

fig. A2.a

(50 mm (2 in) masking tape)

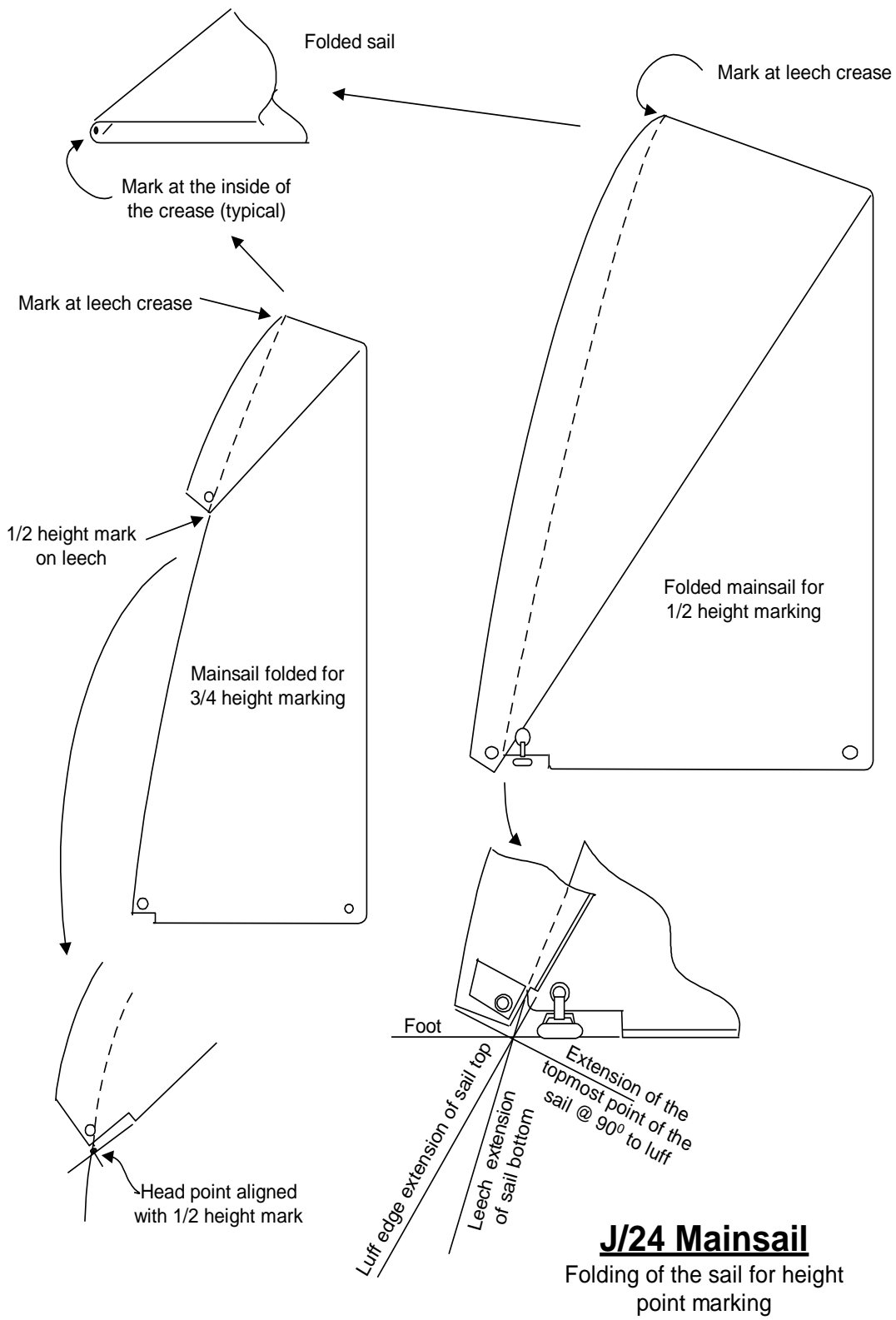
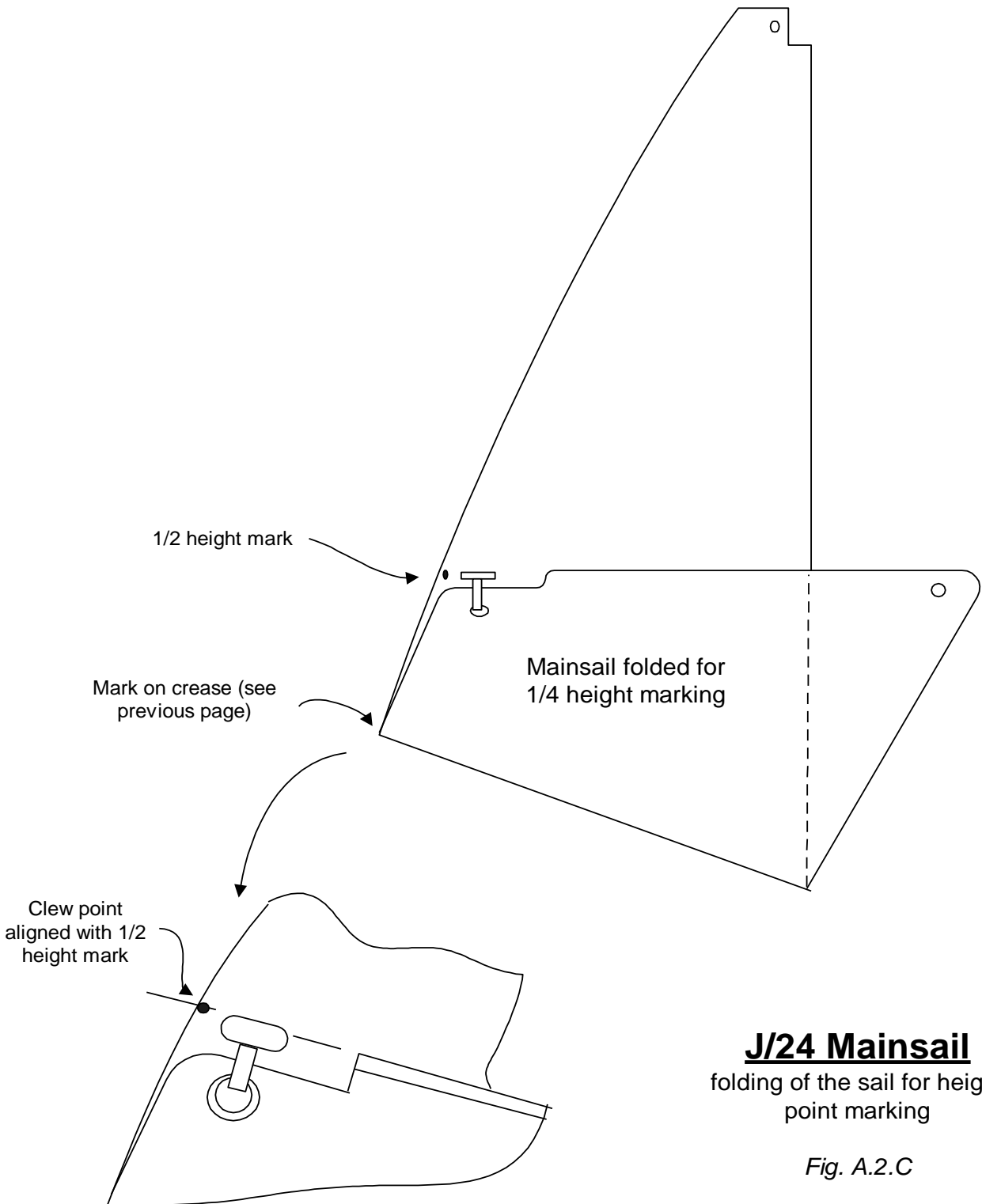

Fig. A.2.b



J/24 Mainsail
folding of the sail for height
point marking

Fig. A.2.C

A.3 Genoa and Jib Layout:

A.3.1 Head Point:

Referring to figure 3.0, place a 150mm long piece of tape along the luff of the layout sail at the head. Place another piece perpendicular to the luff of the sail and mark the Head Point as indicated in the figure. Place a measurement line at 95mm perpendicular to the luff edge of the tape. This is the maximum length of the aft leech corner from the Head Point.

A.3.2. Clew Point:

Using the layout genoa, place two tapes 150-200mm long along the leech and foot of the sail. Add a location point to identify the inside intersect of the tapes as the Clew Point. This will be used to locate the clews of both the genoa and jib.

A.3.3. Genoa luff lengths:

Using the layout sail, place an arc of tape approximately 600mm long (24in.) at 8460mm from the Head Point. Center the arc about the luff line of the sail (figure 3.0). Lift the tack of the sail and place another arc parallel to the first at 8100mm from the Head Point. Identify these as the Maximum Luff and Minimum Luff respectively.

A.3.4. Jib Luff lengths:

The Jib luff lengths are laid out in the same fashion as the genoa but rotated slightly to place them closed to the Clew Point tape. Use a different color marker than the genoa to avoid confusion. The arcs are placed at 8300mm and 7845mm radius from the Head Point and labeled Jib Maximum Luff and Jib Minimum Luff respectively. Note that a layout jib isn't required for these arcs.

A.3.5. Genoa LP dimensions:

Using the layout genoa, on a line from the Clew Point perpendicular to the sail luff, place an arc of tape, approximate 600mm (24in.), with a line at a 4345mm radius (see fig A.3.0). Label the outside of the line as 'Max. Genoa LP'. Lift the sail and add a second arc with a line at a 4180mm radius, labeling the inside of this line as 'Min. Genoa LP'.

A.3.6. Jib LP dimensions:

Using the same Clew Point as the genoa layout, place an arc of tape with a line at a 2895mm radius. As with the luff length marks, using a different marking color will minimize confusion. Having a layout jib will aid in locating the line that is perpendicular to the luff. Label the outside of this line 'Max. Jib LP'. Similarly, place another arc of tape with a line at a 2786mm radius from the Clew Point. Label the inside of this arc 'Min. Jib LP'.

A.3.7. Using the sail layout:

Place the genoa starboard side up over the marks. Verify the head width complies with the 95mm restriction. Holding the head at the Head Point marks, have an assistant (owner rep.) stand on the cringle to prevent movement and, gently stretching the sail luff to eliminate puckers, check the luff length against the marks.

Next, adjust the sail to place the clew on the Clew Point marks, have an assistant stand on the cringle and verify that at least one part of the sail (this will be the shortest distance to the luff) falls within the LP marks. Verify that the balance of the sail requirements (Numbers, hank positions, jib battens, etc.) are met and sign & date the sail across the royalty patch. This same procedure applies to the jib measurements. As before, if any sail specification is not in compliance, DO NOT SIGN THE SAIL UNTIL IT HAS BEEN CORRECTED.

* Radius measured from the head point

** Radius measured from the clew point

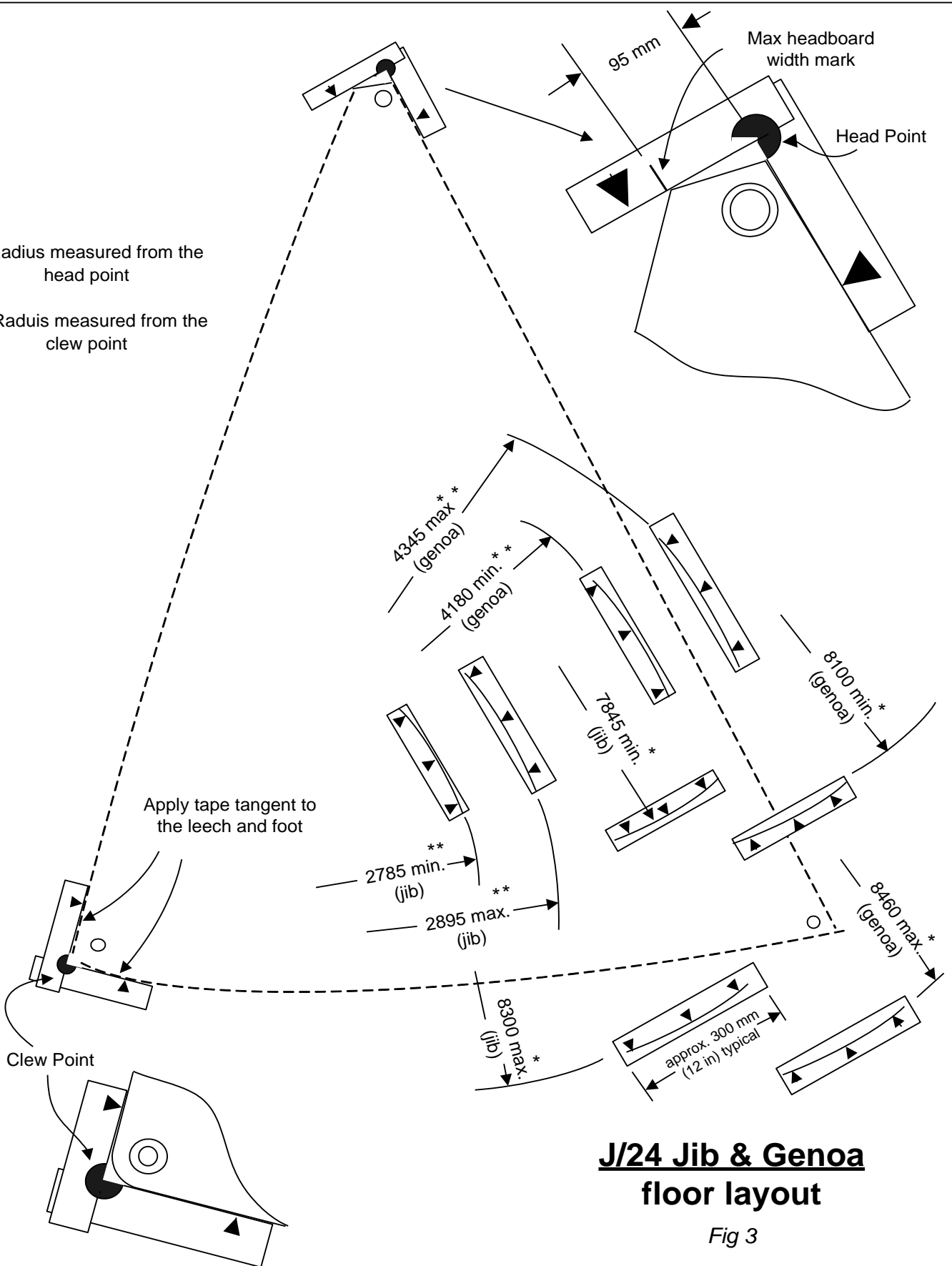

J/24 Jib & Genoa floor layout

Fig 3

(50mm (2 in.) masking tape)

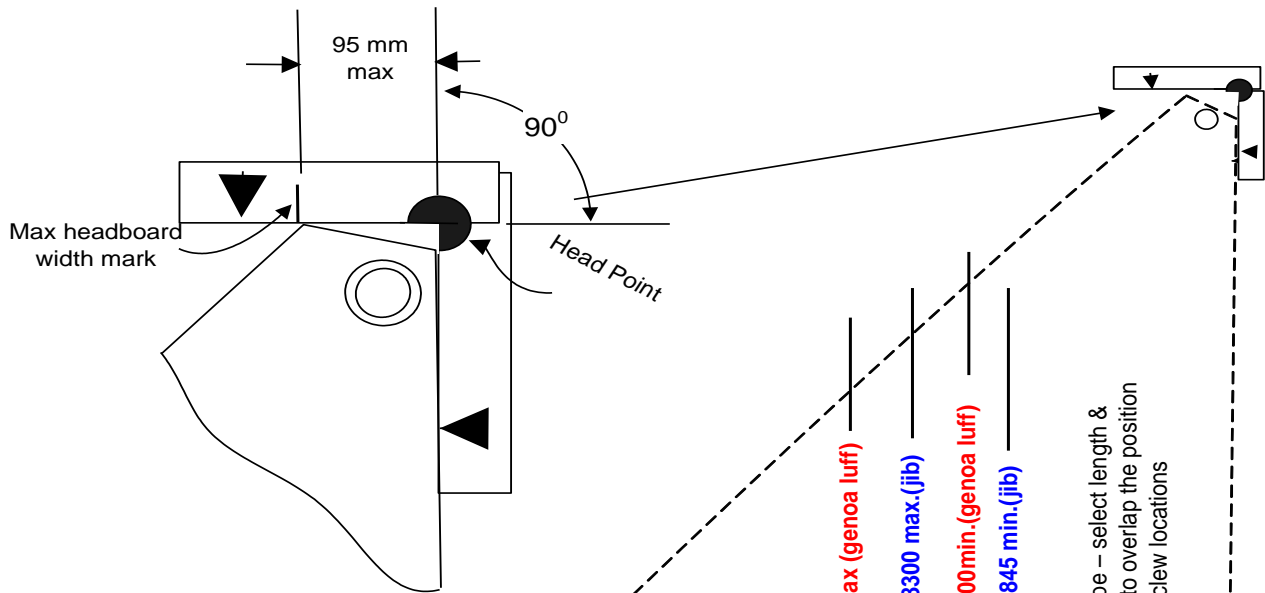

J/24 Jib & Genoa alternate floor layout

Fig 3
(50mm (2 in.) masking tape)
Note color differentiation

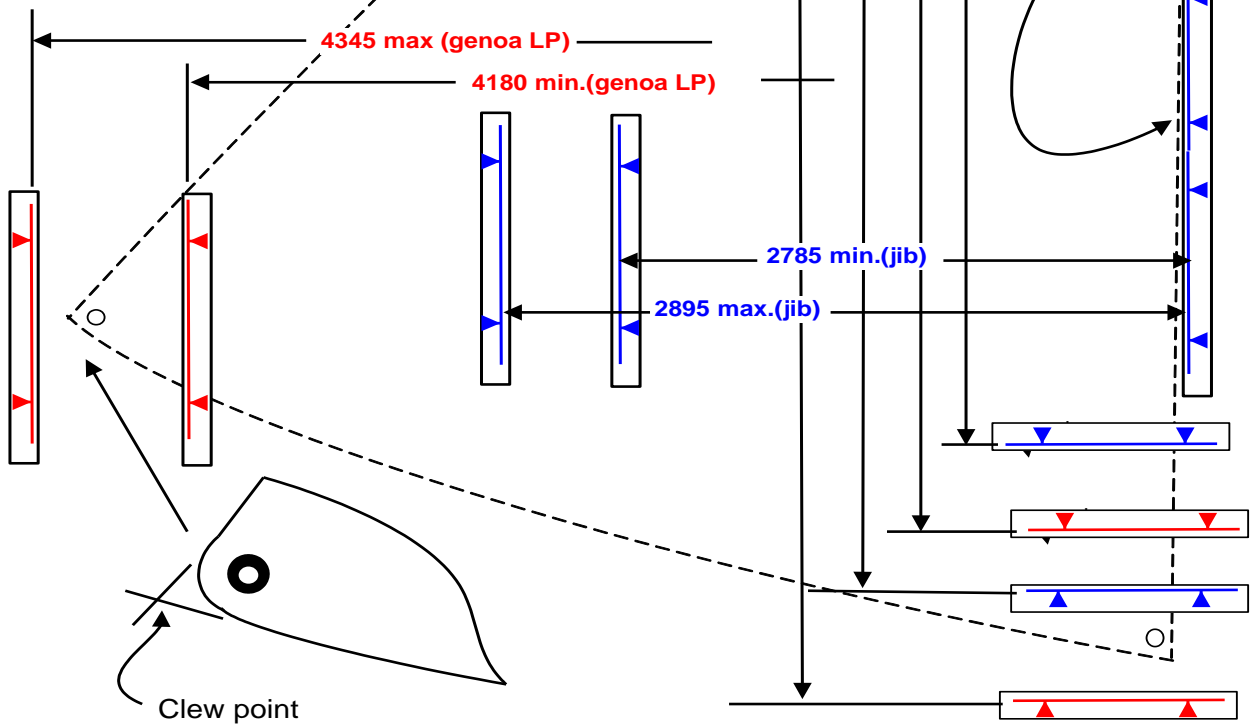

A.4. Spinnaker Layout:

A.4.1. Head Point:

With the layout spinnaker in place (folded along the center seam) and following the diagram in figure 4, place three tape segments across the top and along the leeches of the head of the sail. Mark a target at the center of the top piece and label it 'Head Point'.

A.4.2. Leech marks:

With the layout sail in place, Place an arc of tape approximately 600mm (24in) long with a line at 8130mm measured in a straight line along the leech side of the sail. Identify the outside edge as "Max. Spinnaker Leech". Similarly, place an arc at 7930mm from the same point and label the inside edge 'Min. Spinnaker Leech'.

A.4.3. Clew Mark:

At the clews of the layout sail, place two intersecting tape pieces tangent to the leech and foot of the sail. Mark a locator target and label the tape 'Spinnaker Clew Point' (see figure A.4 for details).

A.4.4. Center Seam lengths:

Using the center seam of the layout sail as a guide, place an approx. 600mm arc of tape with a line at 9600mm radius from the Head Point. The arc should be roughly centered about a line extending the seam. Label the outside edge of this line 'Max. Spinnaker Center Seam'. Note: make this measurement twice. For some reason this value is frequently in error due to mis-reading the measuring tape. Similarly place an arc with a line at 8600mm radius and label the inside of the line 'Min. Spinnaker Center Seam'.

A.4.5. Foot Length:

Measuring from the Clew Point, place a tape arc with a line at 2600mm radius. The arc should lie between the center seam tape arcs. Label the outside edge of the line 'Max. Spinnaker Foot'. Place another arc with a line at 2300mm radius parallel to the first and label it 'Min. Spinnaker Foot'.

A.4.6. Girth marks:

The easiest method of laying out the $\frac{3}{4}$ height and $\frac{1}{2}$ height girth markings uses several assistants and three metal tape measures (otherwise the location marks will take several iterations to arrive at the correct positions). Using the layout sail as a guide, measure 2030mm from the Head Point along the leech edges and place a locator mark on a piece of tape (refer to fig 4). Measure the same distance along the center seam while simultaneously measuring across the girth 1600mm with a third scale and place a measuring target at the intersection of the measuring tapes. Note: extend each measured arc a short distance (150mm) about the intersect point to facilitate measuring the sail. Label the Center seam target as 'Min. Girth'. In use the sail need only exceed this width to comply.

Placing the $\frac{1}{2}$ height marks is again best facilitated using several assistants and three measuring tapes. Begin with a locator mark placed at 4060mm from the Head Point along the leeches of the layout sail. Again simultaneously measuring 4060mm from the Head point and 2540mm from the locator mark, place a measuring target mark at the intersect, again extending the point in a short arc as above. Label the inside of the extended arc 'Min. $\frac{1}{2}$ Height Girth'. In the same fashion, place another measuring target at 2610mm from the leech locator and 4060mm from the Head Point. Label the outside of the arc extension 'Max. $\frac{1}{2}$ Height Girth'.

Remember to also mark the dimension so that the information is available should the need arise.

A.4.7. Using the layout:

Begin by folding the sail about its center seam and placing the on the layout. Placing the sail head point requires folding the head to bring the leeches together. This will be somewhat difficult due to the stiffness of the head reinforcement layers. The intention is to allow the leeches to be measured together. Lightly stretch the leeches to remove folds and form a straight line to the clews, and verify their lengths.

The center seam length is measured in a similar fashion, again with the seam lightly drawn into a straight line. Rarely does the sail exceed this dimension. Therefore, if the initial sail seems marginal, check the position of the Min. / Max. arcs on the floor.

Holding the clews at the Clew Point, verify the $\frac{1}{2}$ foot length.

Again holding the head at the Head Point, draw the sail along the leeches assuring that there are no puckers. Holding the leeches at the locator target, gently draw the sail down the center seam and across the girth to assure the dimension is met.

Similarly draw the sail down the leeches, assuring that both leeches have the same straightening force from the head, and verify the $\frac{1}{2}$ height girth.

As before, verify the balance of the spinnaker specifications are met before signing across the royalty patch.

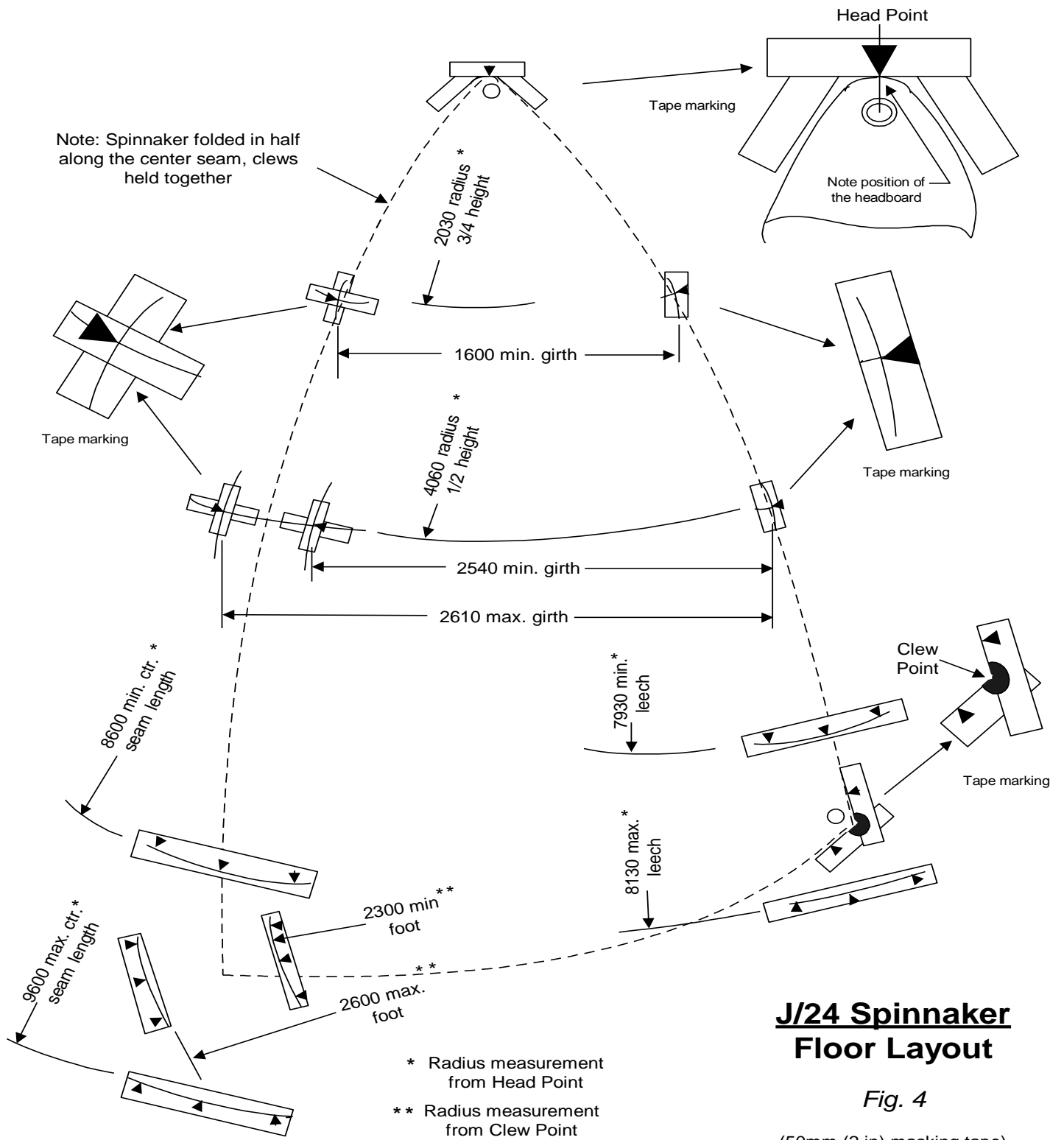

J/24 Spinnaker Floor Layout

Fig. 4

(50mm (2 in) masking tape)

Appendix B. Alternate Sail Measurement

As a means of expediting the measurement of sails the class has developed a set of sail measuring templates that avoid the requirement of taping a floor area as outlined in Appendix A. A diagram of the template set is shown nearby. Note that the approved template set may have a slightly different arrangement of sail placements. Also, the templates have measurement markings that are similar to and are used in the same manner as those found in Appendix A drawings.

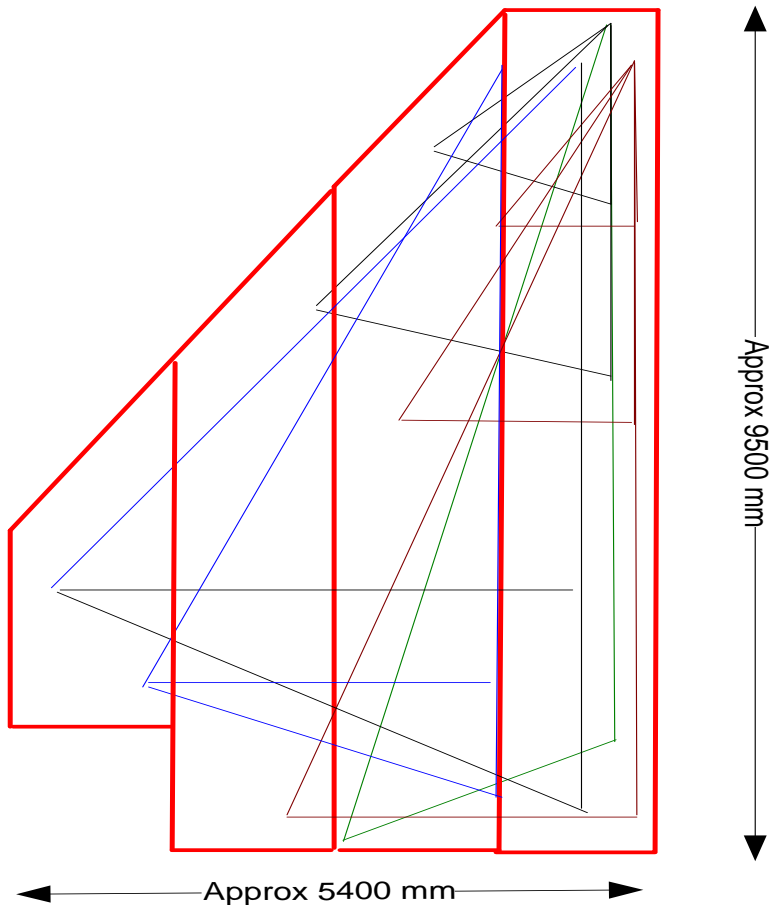



Measurement Form Effective: 1 April 2013

TO OBTAIN A MEASUREMENT CERTIFICATE

1. THE LICENSED BUILDER shall (a) Obtain a hull number (consecutive worldwide) from the copyright holder, J Boats, Inc. (b) Complete Parts B and C of the Measurement Form and deliver one copy with the yacht and one copy to the International J/24 Class Association (IJCA) Office.
2. THE OWNER shall (a) Obtain a sail number in accordance with Racing Rules of Sailing. Unless otherwise allotted in writing to the yacht owner by his NJCA, the sail number shall be the hull number. (b) Complete Part A and deliver one copy to his NJCA, along with his class dues. (c) Have a National Measurer, recognized by the IJCA; take the measurements in Part D of the Measurement Form. (d) Complete the Inventory of Required and Optional Equipment, Rule 3.7.3, and carry a copy aboard his yacht while racing. (Inventory list need not be delivered to the NJCA or the IJCA).
3. THE NATIONAL MEASURER shall (a) Sign and deliver the original Part D of the Measurement Form to the IJCA, sending one copy to the owner, one copy to the NJCA and retaining one copy. (b) Report on the Measurement Form anything considered to be a departure from the intended nature and design of the yacht in accordance with Rule 2.7.6.
4. Upon receipt of completed Parts A, B, C & D by the IJCA and upon verification that all current J/24 Class membership requirements have been met, a Measurement Certificate may be issued. (This may also be done by endorsing the Measurement Form.)
5. CHANGE OF OWNERSHIP shall invalidate the Measurement Certificate and shall require re-registration with the IJCA and the issuance of a new Measurement Certificate. To obtain a new Measurement Certificate, the new owner shall complete and submit Part A to the IJCA, along with a copy of the previous owner's Measurement Certificate, Change of Ownership Declaration if applicable, and a US\$15 processing fee. If alterations have been made, the yacht must be re-measured.

OWNER DECLARATION

Complete Hull No. _____

PART A

Name of Yacht _____ IJCA Membership No. _____ Sail No. _____
 Owner _____ Tel. H: _____ B: _____
 Address _____ City: _____ State _____ Zip _____
 Postal Code _____ Country _____ E-Mail _____
 Co-Owner _____ IJCA Membership No. _____
 Address _____ City: _____ State _____ Zip _____
 Fleet _____ District _____ NJCA _____

I undertake to race this yacht only so long as I maintain it in the conformity with the class rules. I declare that the only sails, spares etc., which have been measured and found to be in accordance with the rules will be used.

Date _____ Owner's Signature _____

BUILDER'S MEASUREMENTS

PART B

Item	Rule	Measurement	Minimum	Actual	Maximum
1	2.8.1	Lead keel weight before assembly	415		435
2b	2.8.2	Builder's Weight	1190		1250
3	2.8.2	Corrector weight required to meet Builder's Weight (2b)			30

BUILDER'S DECLARATION

PART C

To be signed by the Licensed Builder after an IJCA Technical Committee Representative has completed Items 1, 2 and 3, and prior to delivery. I certify that this boat has been: (a) built in moulds obtained by a source approved by J Boats, Inc., (b) constructed according to the official plans specifications and the Rules of the International J/24 Class Association, and (c) built in accordance with the spirit and letter of the J/24 Class Rules and licensing agreement.

Builder's Name _____ Authorized Signature & Printed Name _____ Date _____

IJCA's Technical Committee Representative _____ Signature _____ Date _____

Yacht Name _____ Hull No. _____ Sail No. _____

Item	Rule	Measurement	Min	Actual	Max	Initials
1	3.3.3	Comer of transom to trailing edge of keel:	2996	Y/N	3020	
	a)	at hull				
1a	b)	at 603mm down (section IV)	3095	Y/N	3125	
1b	3.2.7	Radius of comer is 2mm or greater		Y/N		
2	3.3.4	Leading and trailing edges of keel between Sections I and VI are within +/- 5mm of a straight line (see <i>MM interpretation 2.4</i>)		Y/N		
2a	3.3.2	Trailing edge of the keel does not exceed 965mm		Y/N	965	
3a	3.3.2	Width of keel trailing edge at Section I, 12.8mm or greater		Y/N		
3b	3.3.2	from Section II to VI 3.6mm or greater		Y/N		
4	3.3.2	Does keel comply with minimum faired dimensions of Plan C at Sections I-VI?		Y/N		
5	3.3.2	Do you believe the keel complies with minimum faired dimensions of Plan C elsewhere?		Y/N		
6a	3.1.1	Hull profile width of molded keel stub: at top of trailing edge, 22mm or greater		Y/N		
6b	3.1.1	at 19mm below fairbody, 760mm around the contour from 30mm down from the comer of the trailing edge, 185mm or greater (see <i>MM interpretation 2.5</i>)		Y/N		
7	3.4.3	Weight of rudder, tiller extension and fittings	13.5 kg	Y/N		
8a	3.4.2	Width of rudder trailing edge 4mm or greater		Y/N		
8b	3.4.2	Cord length of rudder between 300mm and 305mm.		Y/N		
8c	3.4.2	Does rudder comply with minimum faired dimensions of plan D		Y/N		
9	3.4.2	The depth of the rudder measured between the rudder tip and the transom is no less than 860 or more than 890mm	860	Y/N	890	
10	3.4.7	Is leading edge of the rudder parallel to extension of line from transom within +/-10mm?		Y/N		
11	3.5.2e	Distance between forestay attachment and permanently marked lower edge of bottom band is 7725mm		Y/N		
12	3.5.2d	Distance between mast bands (P)		Y/N	8538	
13	3.5.2f	Location of highest spinnaker boom attachment above lower edge of bottom band		Y/N	1555	
14	3.5.3	Standard installed fixed spreader length	760	Y/N	800	
15	3.5.3	Spreader sweepback distance No longer in use	95			
16	3.5.6	Length of spinnaker boom including fittings		Y/N	2895	
17	3.5.6	Weight of spinnaker boom including fittings	2.7kg	Y/N		
18	3.5.3b	Height of forestay attachment above sheerline (I) abreast forward surface of mast	8125	Y/N		
19	3.5.3c	Distance between fixing point of the forestay on mast and intersection of stemline and sheerline	8595	Y/N	8670	



Measurement Form (Cont.)

YACHT MEASUREMENTS

PART D (Cont.)

Yacht Name _____ Hull No. _____ Sail No. _____

Item	Rule	Measurement	Min	Actual	Max	Initials
20	3.5.2b	Distance from bottom mast band to the stem at sheerline	2895	Y/N	2925	
21	3.5.2c	Mast chocked to prevent movement at deck and bolted so as not to move on the mast bearing beam		Y/N		
22	3.5.4	Does running rigging comply with the Class Rules		Y/N		
23	3.5.5c	Distance of 20mm boom band from mast (E)		Y/N	2970	
23b		Tip weight of boom measured at outhaul when horizontal on mast without mainsheet and vang fittings 3.3kg or greater		Y/N		
24	3.2.5	Upper lifelines 500mm minimum above sheerline		Y/N		
25	3.2.5	Lifeline stanchions inboard of sheer in plan		Y/N		
26	3.2.4	Sink/drain/water tank or stove/fuel fitted		Y/N		
27	3.1.4 3.8 8.1.2 8.1.3	Fixed fittings and equipment located according to Class Rules		Y/N		
28		Dry weight without additional correctors				
29	3.7.2	Total weight of additional correctors				
30	3.7.1	Basic Yacht Weight	1270 kg			
31	3.1.1 3.1.8	Illegal metals scan has been completed with clear results		Y/N		

MEASURER'S COMMENTS

MEASURER'S DECLARATION

I declare that the measurements recorded above were taken by me (or another qualified measurer), and that to the best of my knowledge and belief this yacht complies with the International J/24Class Rules

Location _____ Measurer's Printed Name _____ Measurer's Authority _____

Measurer's Signature _____ Date _____ Measurer's E-Mail _____



INVENTORY OF REQUIRED & OPTIONAL EQUIPMENT

PART C

Rule 3.7.3

Owner's Name _____ Complete Hull No. _____
 Name of Yacht _____ Sail No. _____

Rule	Item	Weight In kg.
3.7.1	Basic Yacht Weighed Dry (Item 30 from Part D)	_____

Required Items

3.6.10	Mainsail	_____
3.6.11	Jib	_____
3.6.12	Genoa	_____
3.6.13	Spinnaker	_____
3.8.7	Anchor with or without chain (6kg min.)	_____
3.8.8	Outboard motor (14kg min.)	_____
3.8.9	Motor fuel container and minimum of 2 liters of fuel	_____
4.1.7	Life jackets (number ____)	_____
4.1.8	Throwable life saving device with attached sea anchor	_____
3.8.5	Bilge pump and/or bucket (Weigh items below in bucket)	_____
4.1.4	Foghorn	_____
*4.1.5	One water resistant flashlight	_____
4.1.6	Fire extinguishers (number ____)	_____
4.1.9	Hacksaw or similar equipment	_____
4.1.10	First aid kit and manual	_____

Optional Items

6.1.7	Storm trysail and/or jib	_____
6.1.8	Spare wood tiller	_____
6.1.8	Spare, measured rudder	_____
6.1.8	Spare, measured spinnaker boom	_____
6.1.24	4 berth cushions not exceeding 21kg.	_____
6.1.25	Companionway step box or icebox not exceeding 9Kg empty.	_____
6.1.26	Fresh water (10 kg. max.).	_____
6.1.27	12-volt battery (25kg max)	_____
Other:	Fenders (number: ____)	_____
	Rulebooks	_____
	Tool box	_____
	Spare sailing equipment (specify type)	_____



3.7.3 ALL-UP WEIGHT FOR RACING: (1330kg min.) _____

Manufacturer and serial number:
 Outboard _____ Battery _____

I certify that all of the above scheduled equipment is aboard my yacht and will remain as described while racing. A copy of this inventory shall be carried aboard my yacht while racing.

Owner's Signature _____ Date Signed _____